

4102107

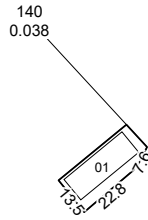

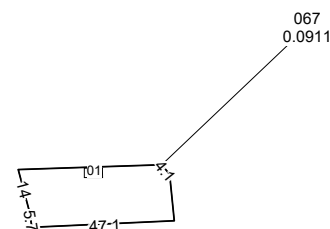
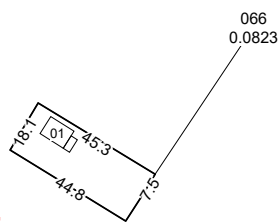

4102108

4102115

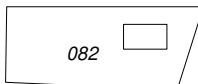

SEMNE CONVENȚIONALE

 - numărul cadastral al parcelei

  - numărul poștal

4102107 - codul cadastral al sectorul

Directorul firmei _____/semnătura/

Specialistul licențiat _____/semnătura/

Planul cadastral întocmit de _____/semnătura/

Data tipării: 10.05.2022

Scara 1:2000

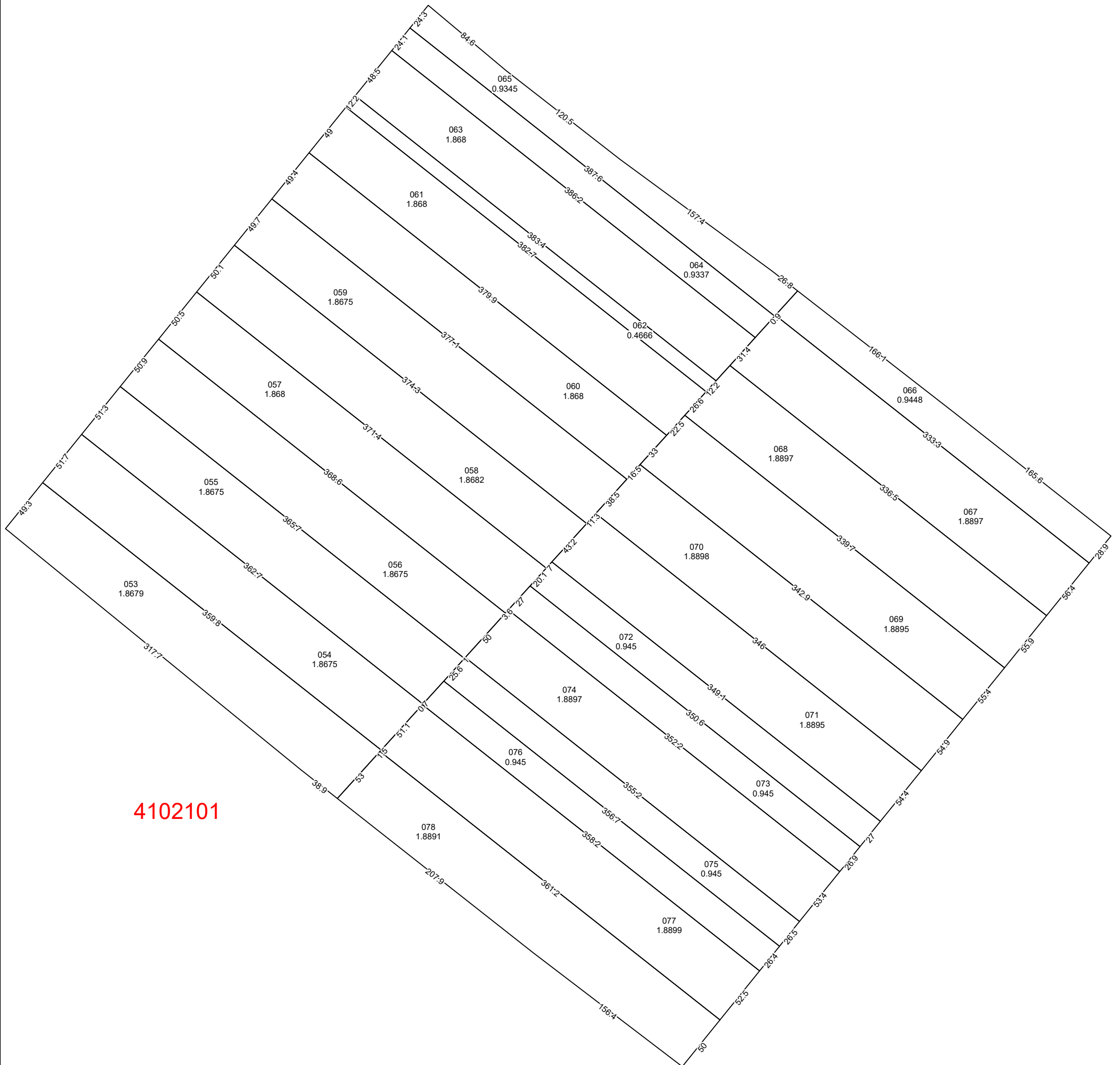

4102101



Directorul firmei _____/semnătura/
Specialistul licențiat _____/semnătura/
Planul cadastral întocmit de _____/semnătura/
Data tipării: 10.05.2022

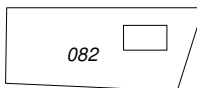

Scara 1:2000

SEMNE CONVENȚIONALE

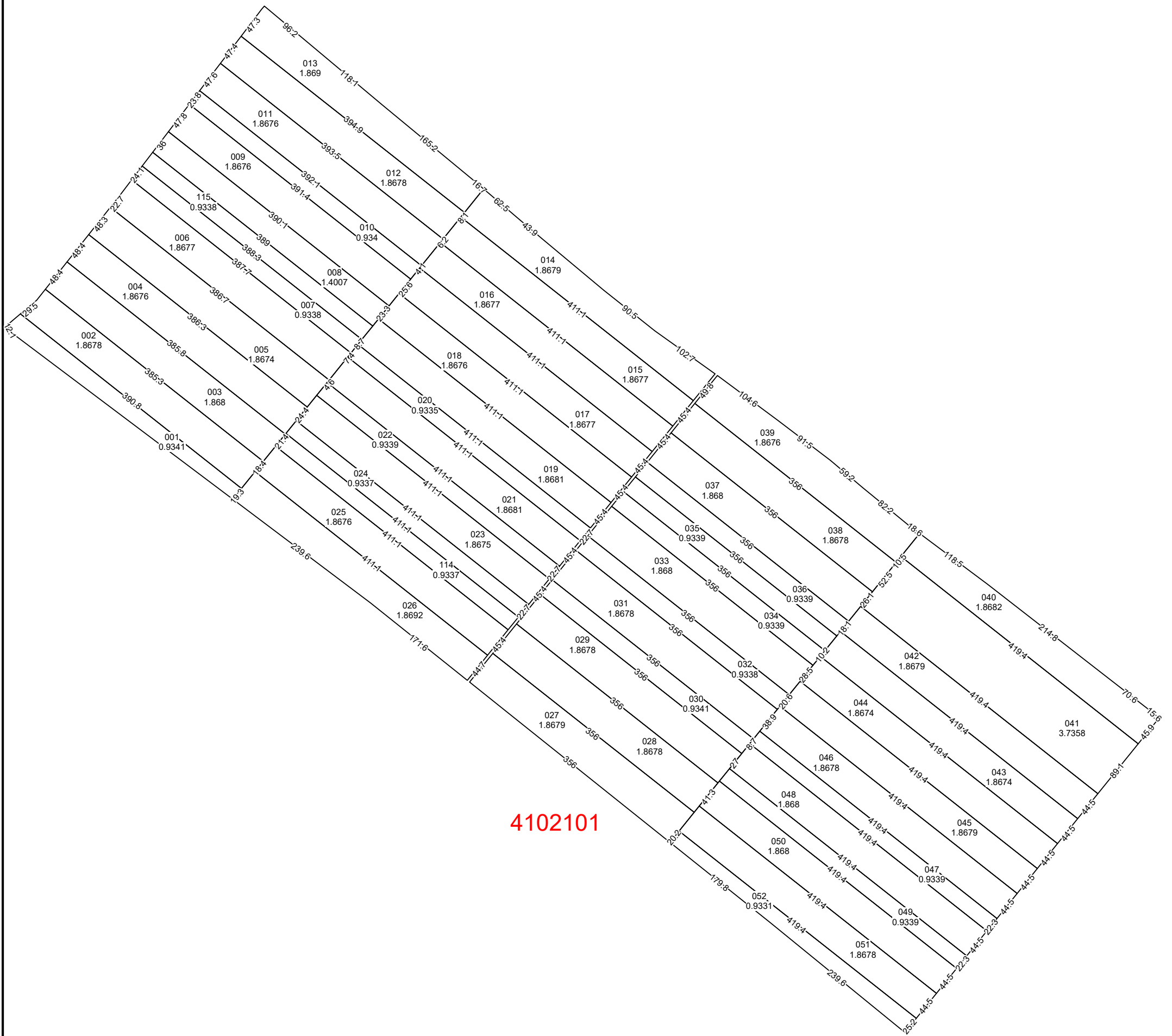
-  082 - numărul cadastral al parcelei
-  12  614a - numărul poștal
- 4102101 - codul cadastral al sectorului

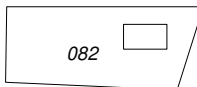

SEMNE CONVENȚIONALE

-  - numărul cadastral al parcelei
-   - numărul poștal
- 4102101** - codul cadastral al sectorul

Directorul firmei _____/semnătura/
Specialistul licențiat _____/semnătura/
Planul cadastral întocmit de _____/semnătura/
Data tipării: 10.05.2022

Scara 1:2000

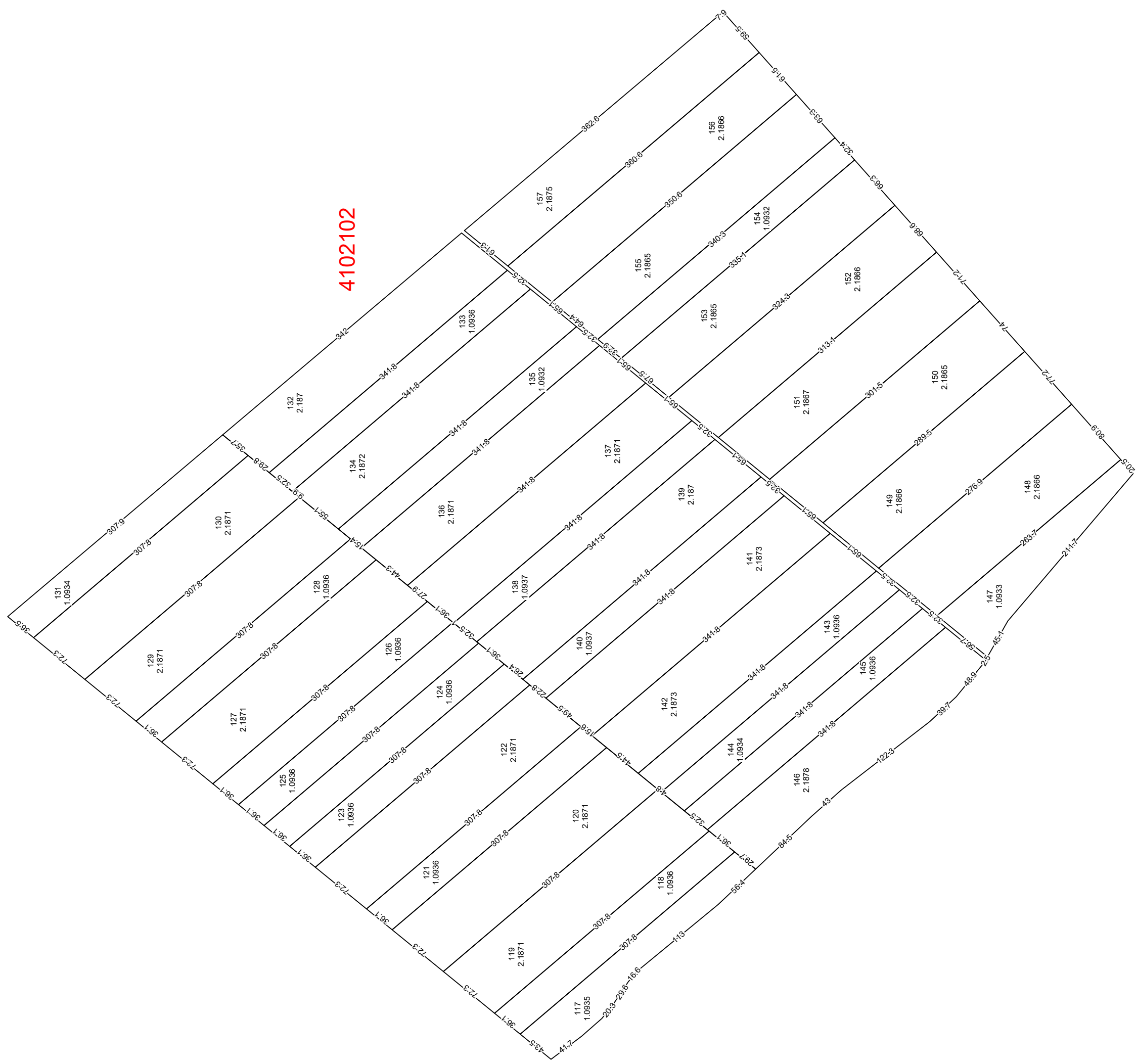

SEMNE CONVENȚIONALE

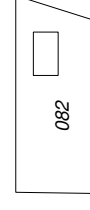

082 - numărul cadastral al parcelei

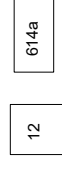

12 - numărul poștal

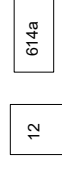

614a - numărul cadastral al sectorului

Scara 1:2000

Directorul firmei _____/semnătura/
Specialistul licențiat _____/semnătura/
Planul cadastral întocmit de _____/semnătura/
Data tipării: 10.05.2022

4102102 - codul cadastral al sectorului

4102102

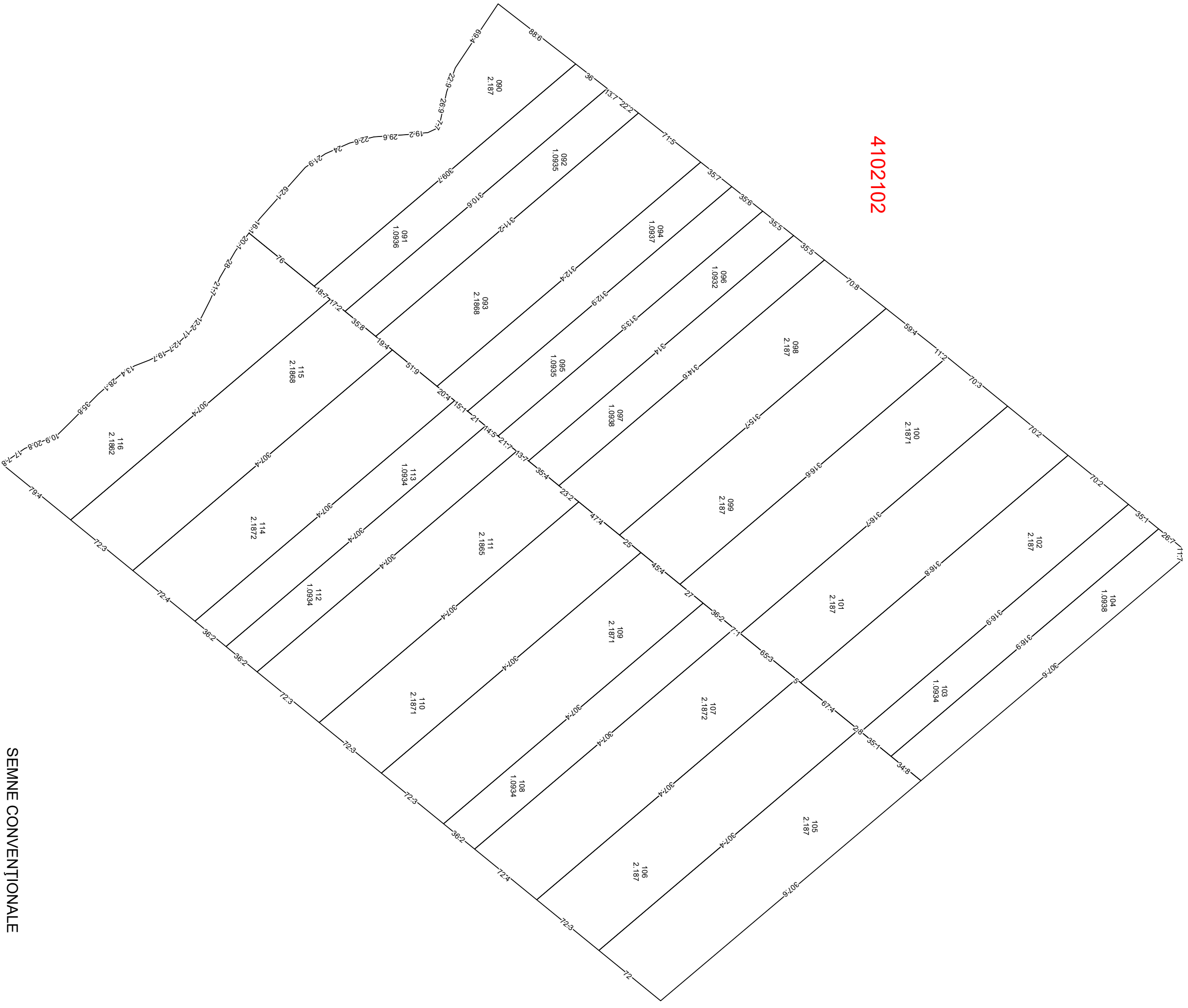

SEMNE CONVENTIONALE

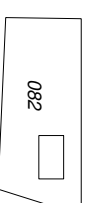

- numărul cadastral al parcelei

12

614a

- numărul poștal

4102102

- codul cadastral al sectorului

Directorul firmei _____ /semnătura/
Specialistul licențiat _____ /semnătura/
Planul cadastral întocmit de _____ /semnătura/
Data tipăririi: 10.05.2022

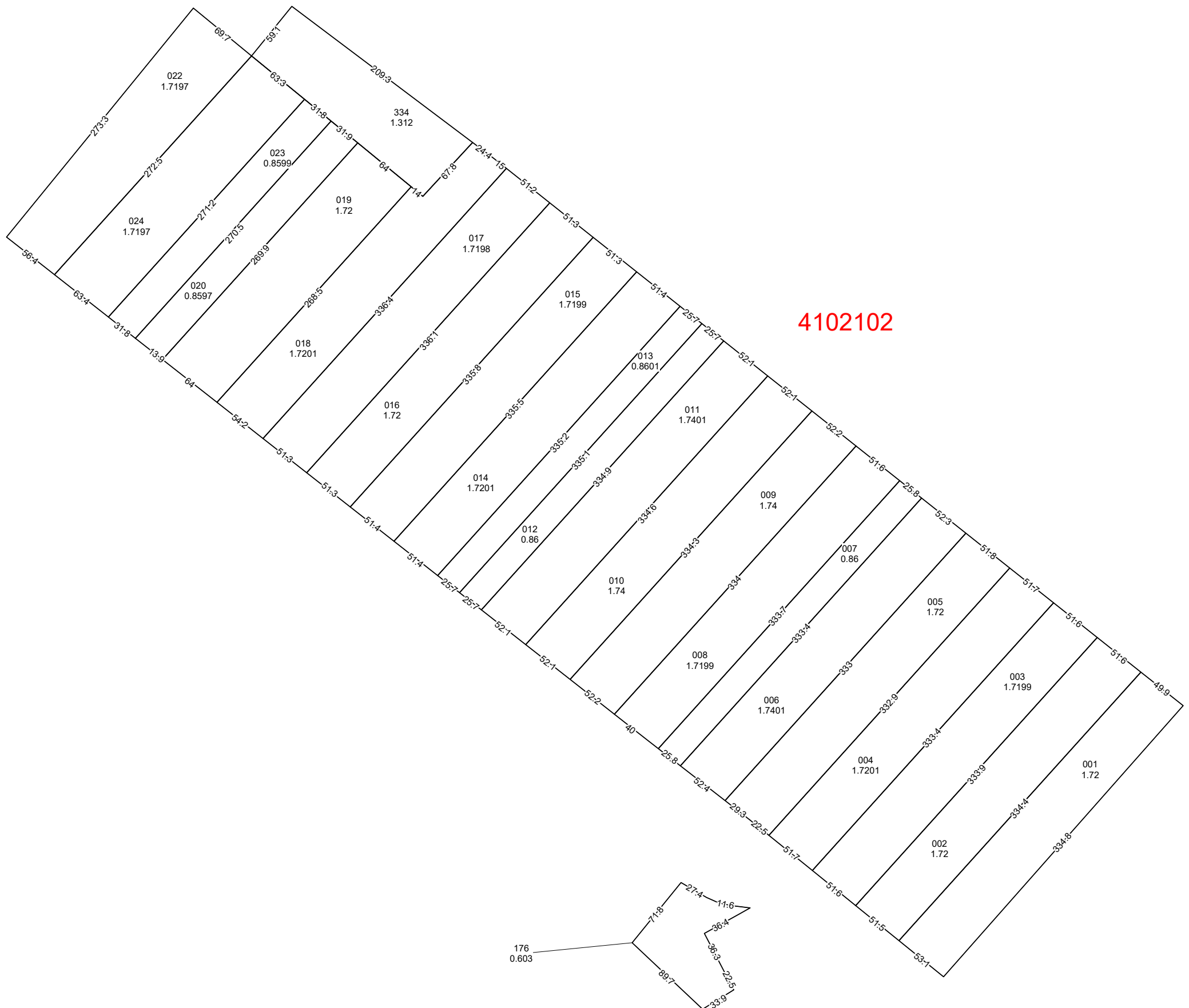

Scara 1:2000



Directorul firmei _____/semnătura/
Specialistul licențiat _____/semnătura/
Planul cadastral întocmit de _____/semnătura/
Data tipării: 10.05.2022

Scara 1:2000

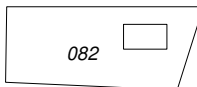

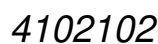
SEMNE CONVENȚIONALE

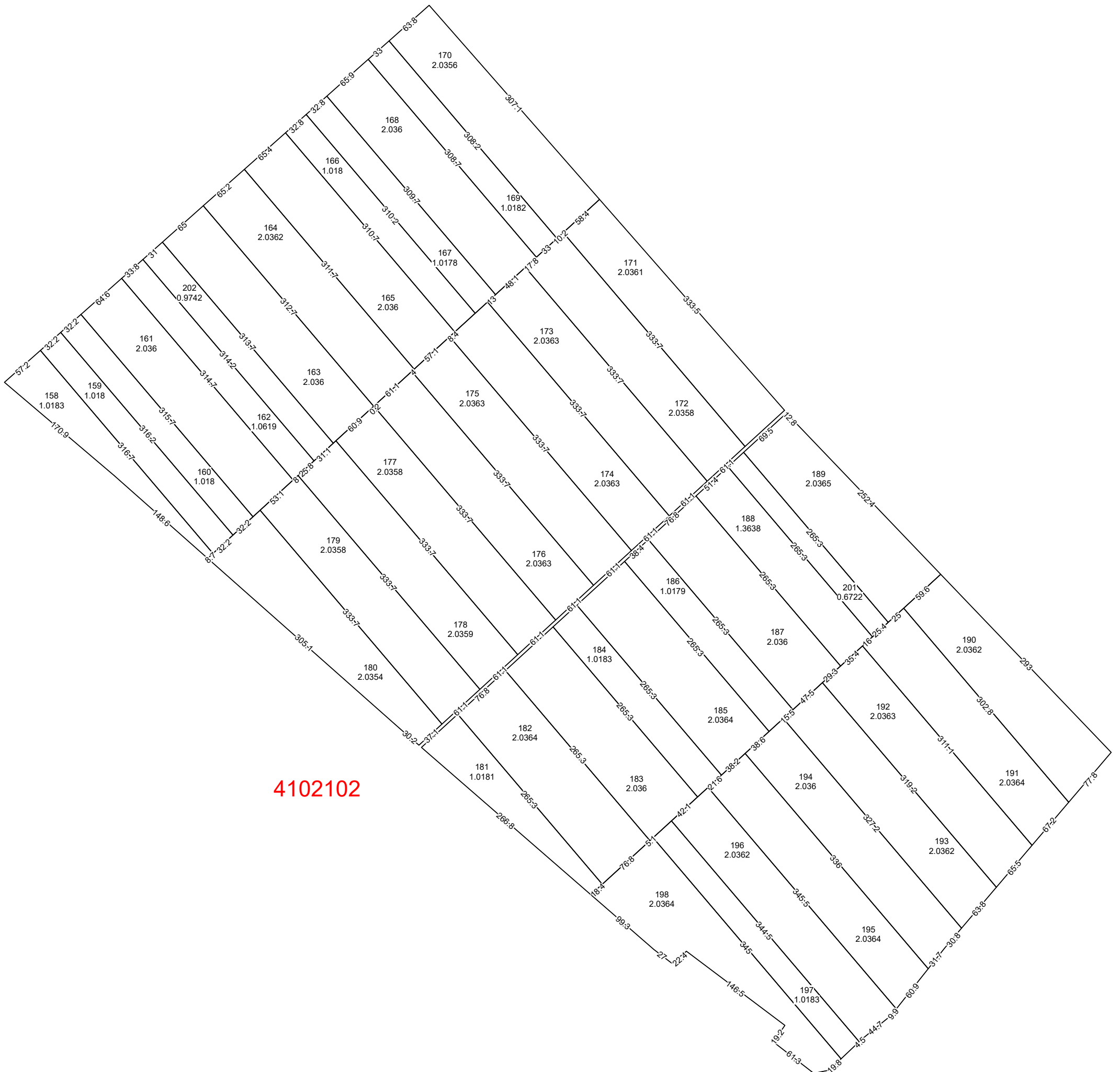
-  - numărul cadastral al parcelei
-   - numărul poștal
-  - codul cadastral al sectorul

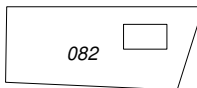

4102102

SEMNE CONVENȚIONALE

-  082 - numărul cadastral al parcelei
-  12  614a - numărul poștal
- 4102102 - codul cadastral al sectorul

Directorul firmei _____/semnătura/
Specialistul licențiat _____/semnătura/
Planul cadastral întocmit de _____/semnătura/
Data tipării: 10.05.2022

Scara 1:2000

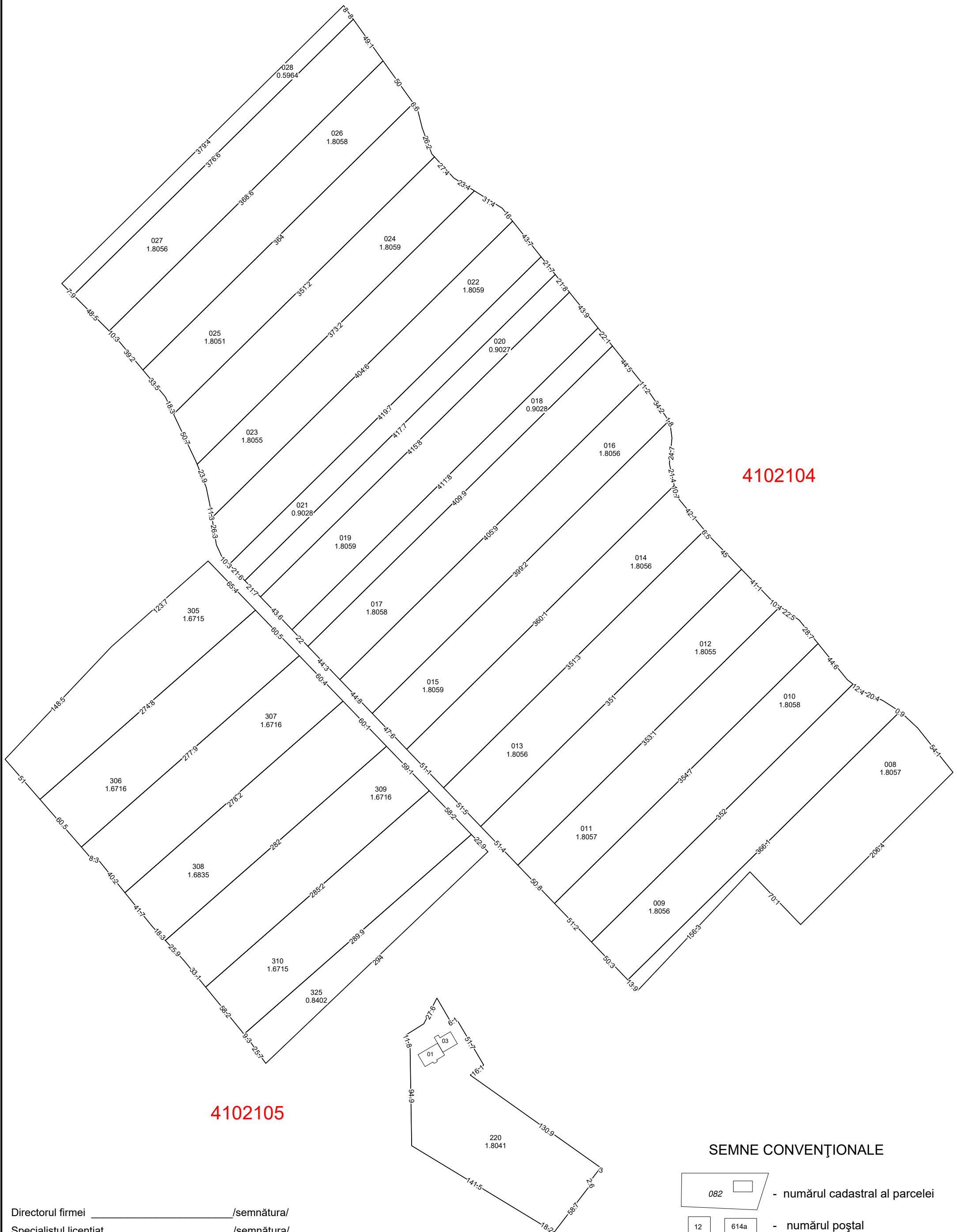

Directorul firmei _____/semnătura/
Specialistul licențiat _____/semnătura/
Planul cadastral întocmit de _____/semnătura/
Data tipării: 10.05.2022

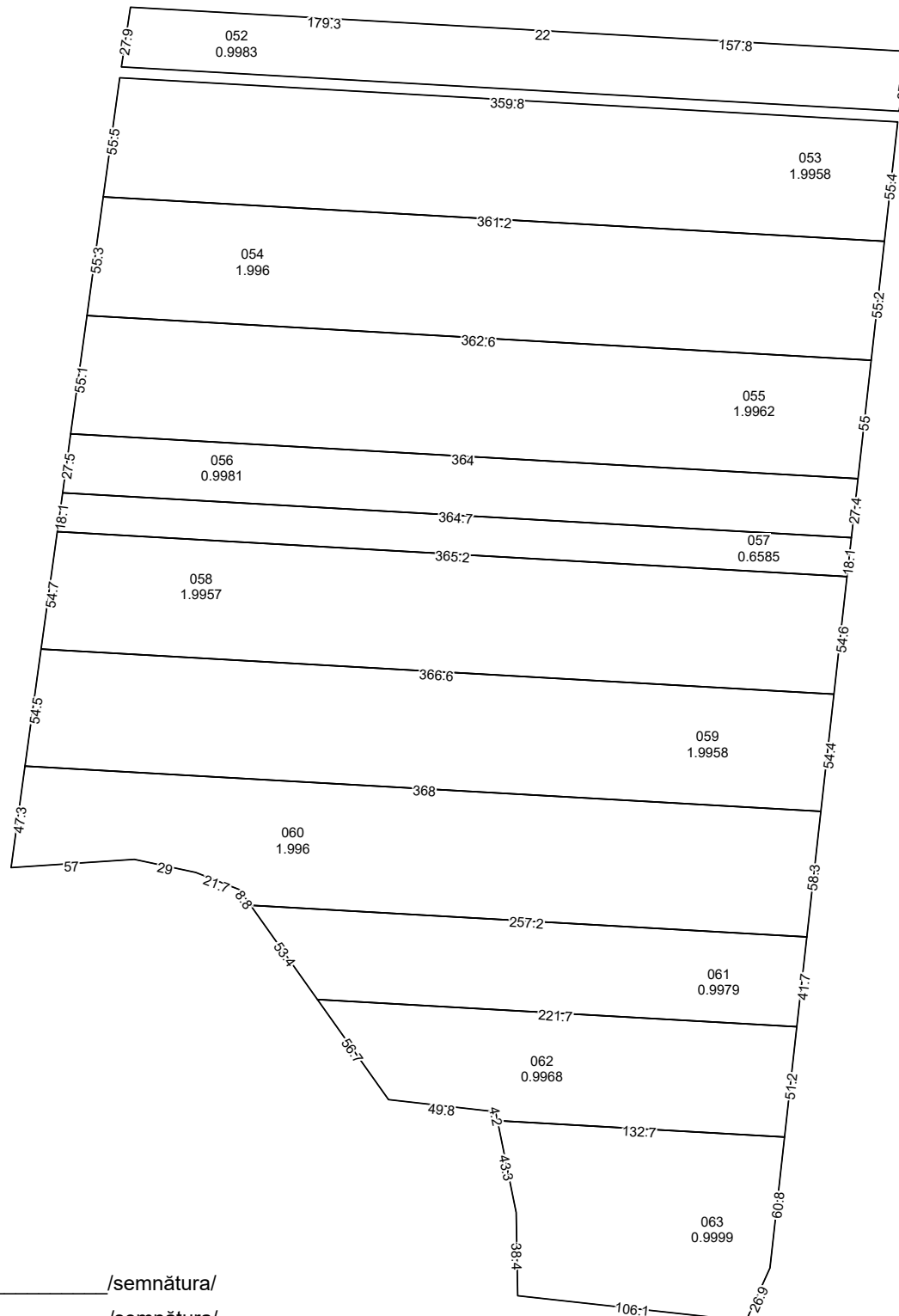
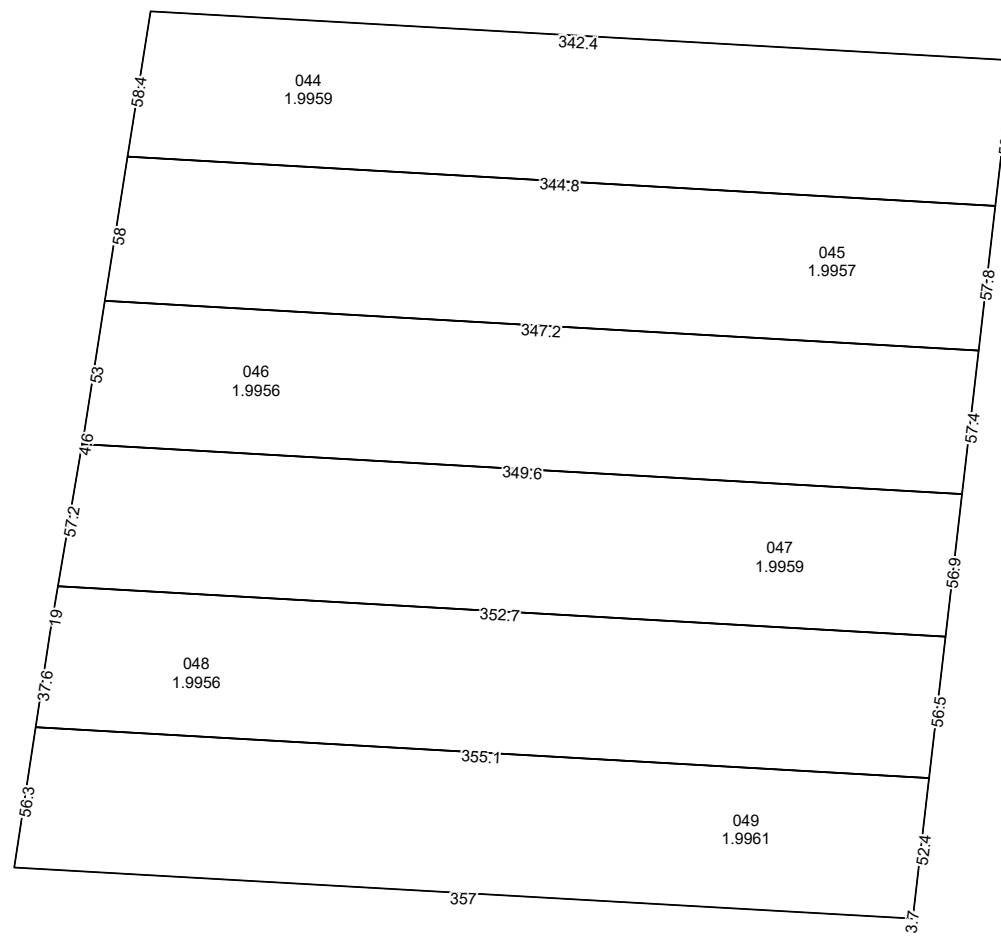



4102117

Directorul firmei _____/semnătura/
Specialistul licențiat _____/semnătura/
Planul cadastral întocmit de _____/semnătura/
Data tipării: 10.05.2022

Scara 1:2000

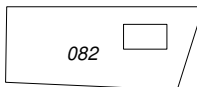
SEMNE CONVENȚIONALE

-  - numărul cadastral al parcelei
-   - numărul poștal
- 4102117 - codul cadastral al sectorul

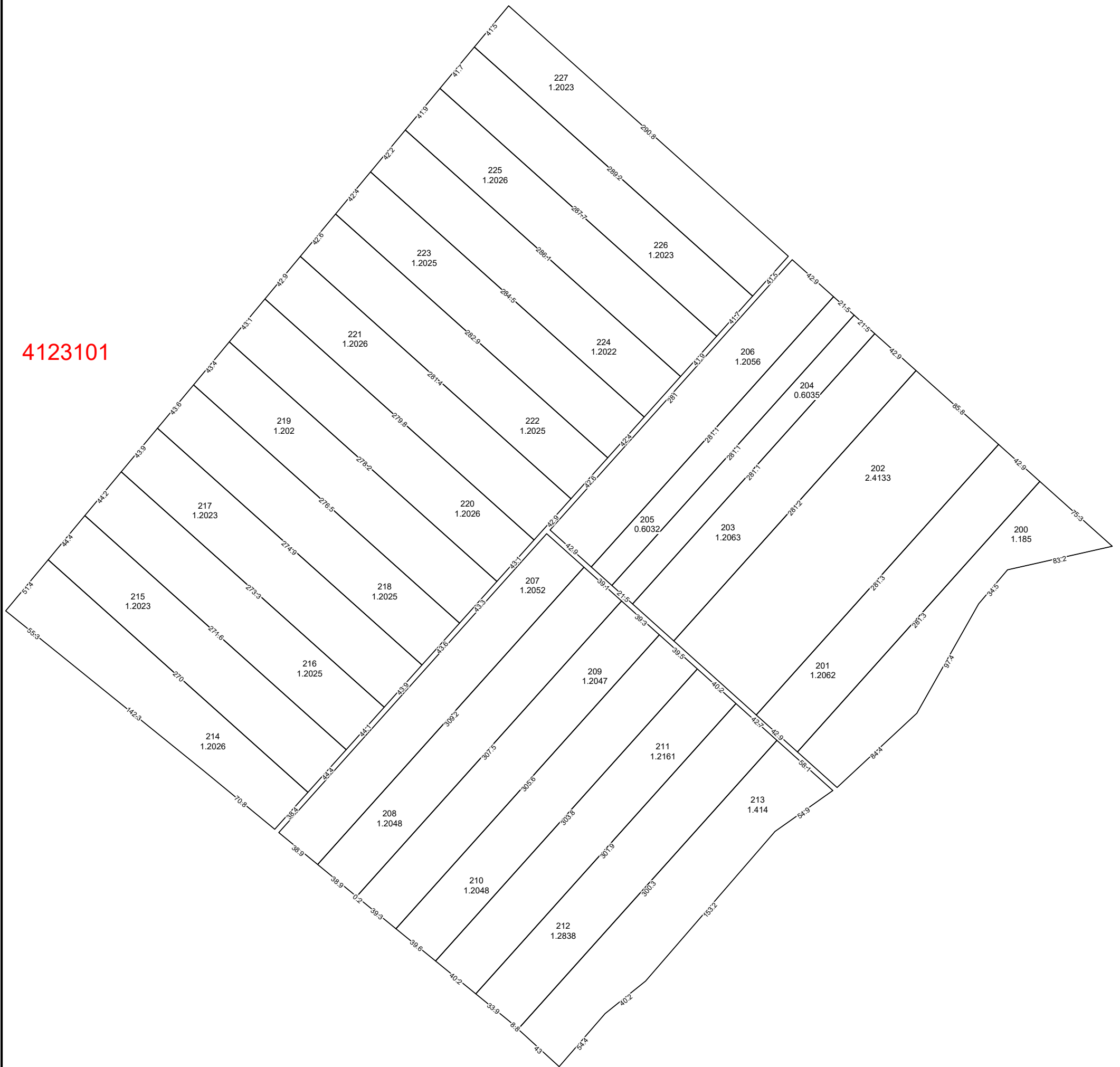

4123101

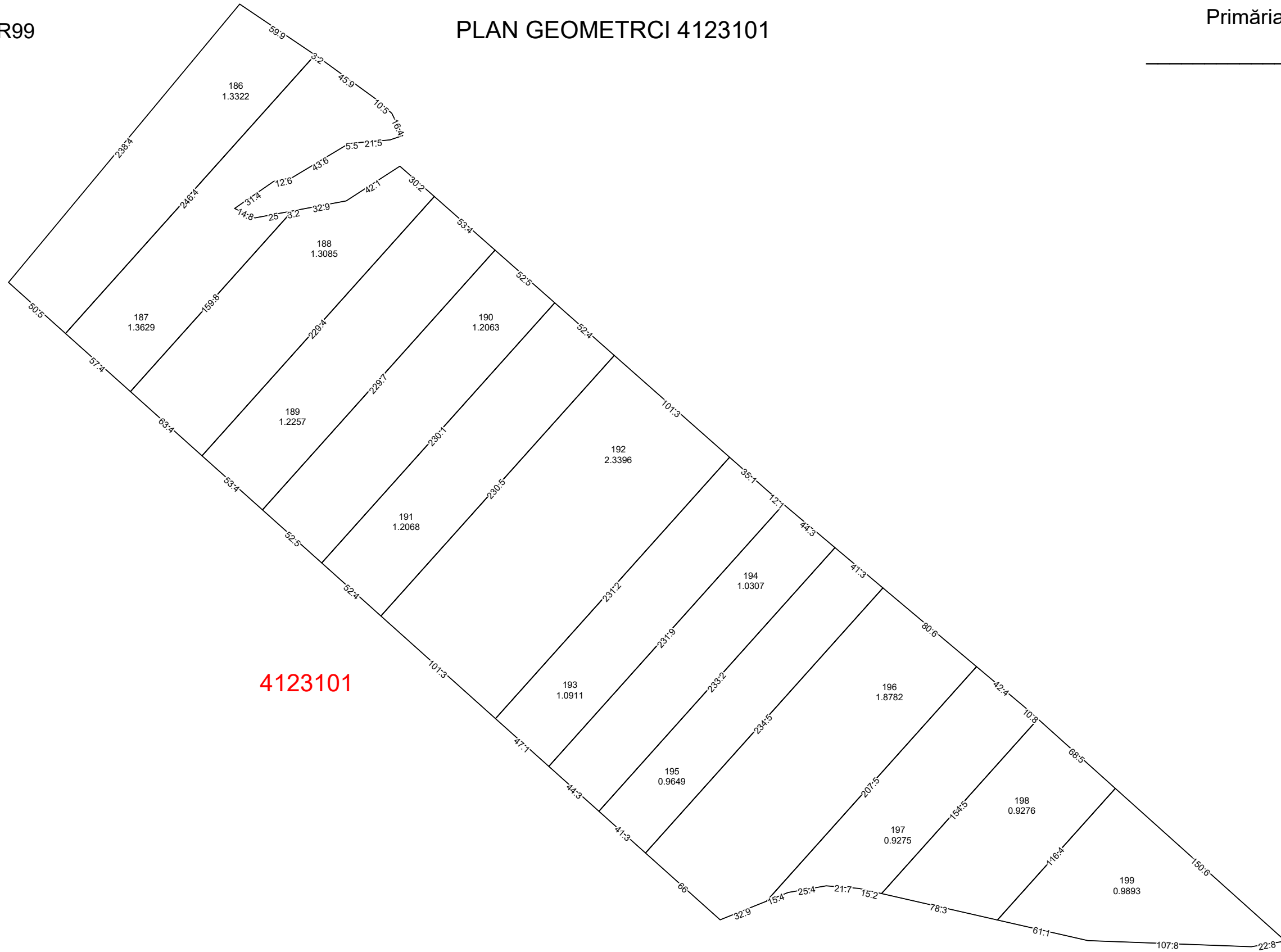

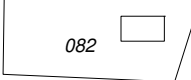

4123101

SEMNE CONVENȚIONALE

-  - numărul cadastral al parcelei
-   - numărul poștal
- 4123101** - codul cadastral al sectorului

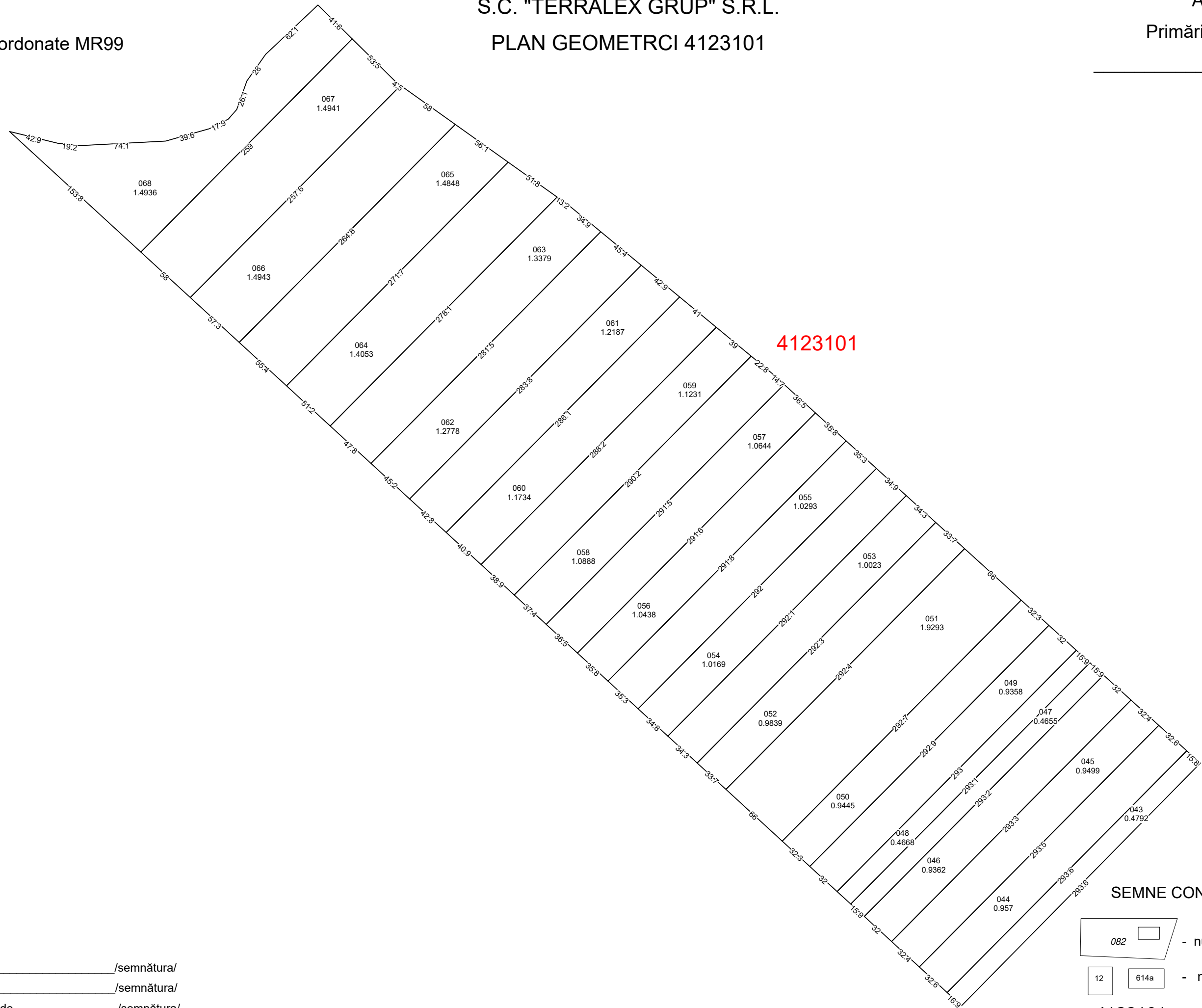

Directorul firmei _____/semnătura/
Specialistul licențiat _____/semnătura/
Planul cadastral întocmit de _____/semnătura/
Data tipării: 10.05.2022

Scara 1:2000

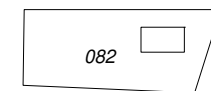

4123101

SEMNE CONVENȚIONALE

-  - numărul cadastral al parcelei
-   - numărul poștal
- 4123101** - codul cadastral al sectorul

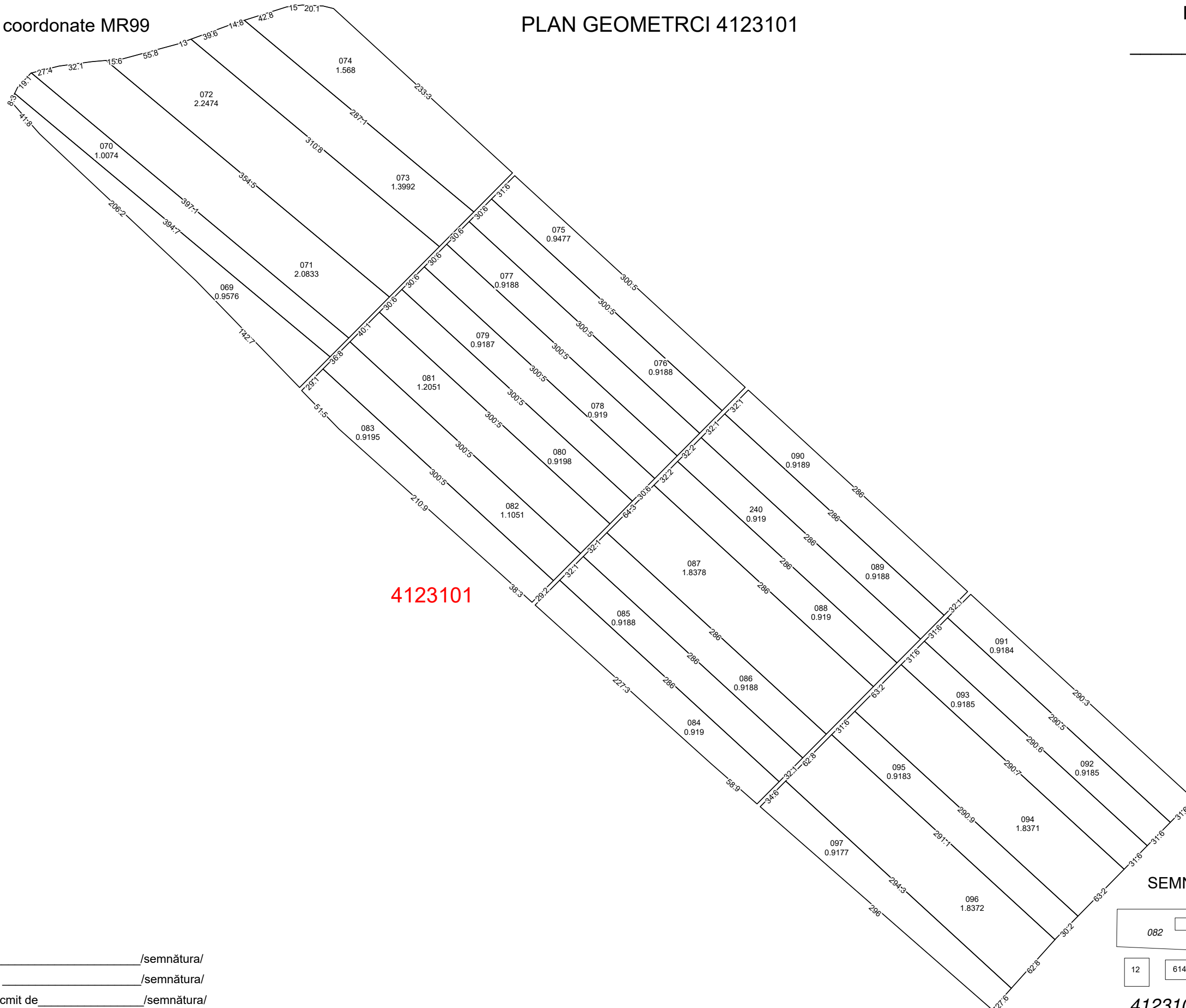

Directorul firmei _____/semnătura/
Specialistul licențiat _____/semnătura/
Planul cadastral întocmit de _____/semnătura/
Data tipării: 10.05.2022

Scara 1:2000

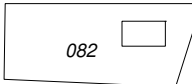

4123101

SEMNE CONVENȚIONALE

-  082 - numărul cadastral al parcelei
-  12  614a - numărul poștal
- 4123101 - codul cadastral al sectorului

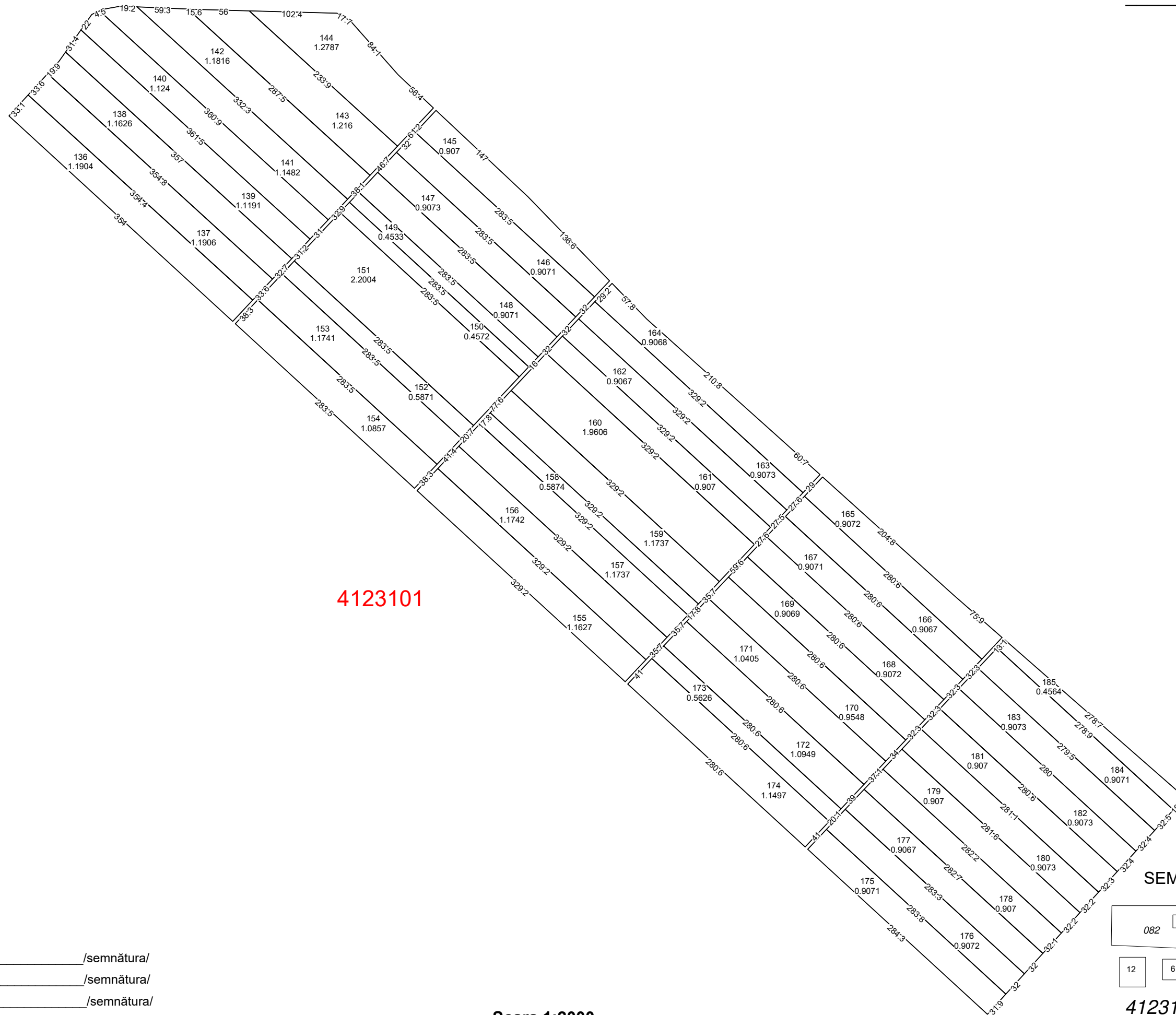

Directorul firmei _____/semnătura/
Specialistul licențiat _____/semnătura/
Planul cadastral întocmit de _____/semnătura/
Data tipării: 10.05.2022

Scara 1:2000

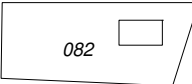

4123101

SEMNE CONVENȚIONALE

-  - numărul cadastral al parcelei
-   - numărul poștal
- 4123101** - codul cadastral al sectorului

Directorul firmei _____/semnătura/
Specialistul licențiat _____/semnătura/
Planul cadastral întocmit de _____/semnătura/
Data tipării: 10.05.2022

Scara 1:2000



4123101

SEMNE CONVENȚIONALE

082 - numărul cadastral al parcelei

12 614a - numărul poștal

4123101 - codul cadastral al sectorului

Directorul firmei _____/semnătura/
Specialistul licențiat _____/semnătura/
Planul cadastral întocmit de _____/semnătura/
Data tipării: 10.05.2022

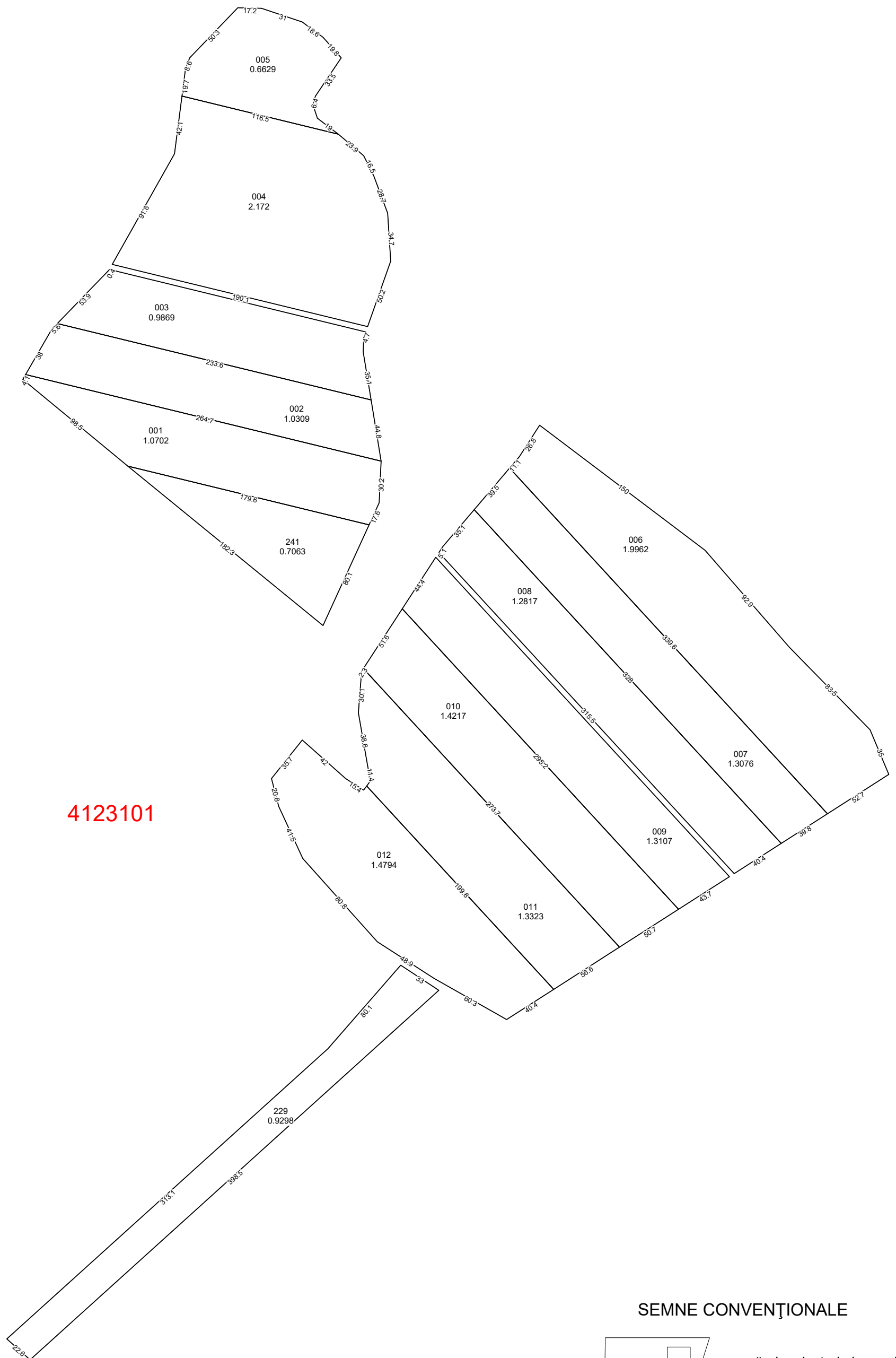

Scara 1:2000



Directorul firmei _____/semnătura/
Specialistul licențiat _____/semnătura/
Planul cadastral întocmit de _____/semnătura/
Data tipării: 10.05.2022

Scara 1:2000

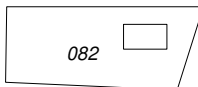

SEMNE CONVENȚIONALE

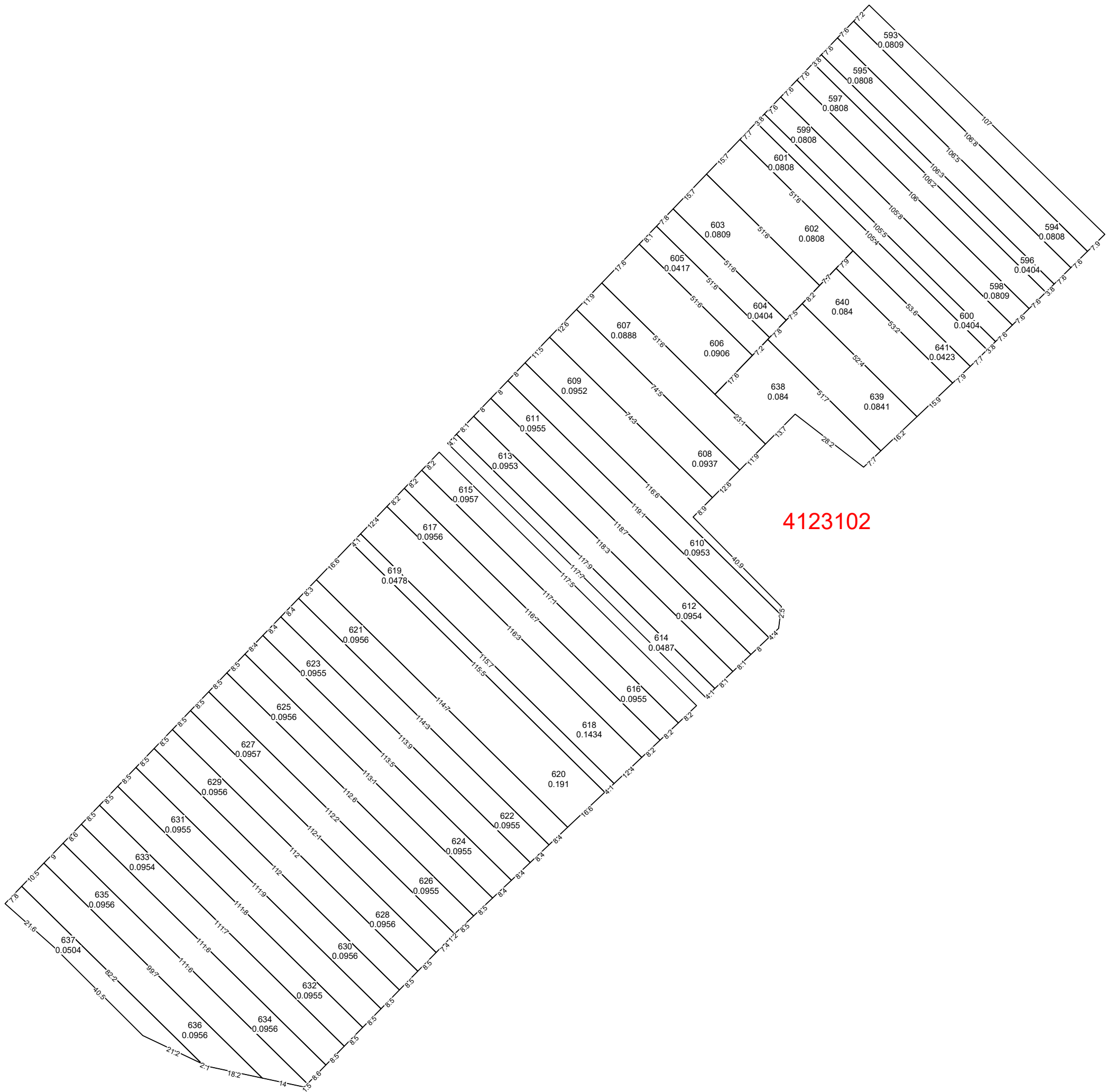
-  - numărul cadastral al parcelei
-   - numărul poștal
- 4123101** - codul cadastral al sectorului

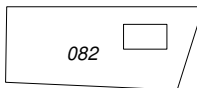

4123102

SEMNE CONVENȚIONALE

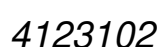
-  - numărul cadastral al parcelei
-   - numărul poștal
-  - codul cadastral al sectorul

Directorul firmei _____/semnătura/
Specialistul licențiat _____/semnătura/
Planul cadastral întocmit de _____/semnătura/
Data tipării: 10.05.2022

Scara 1:2000

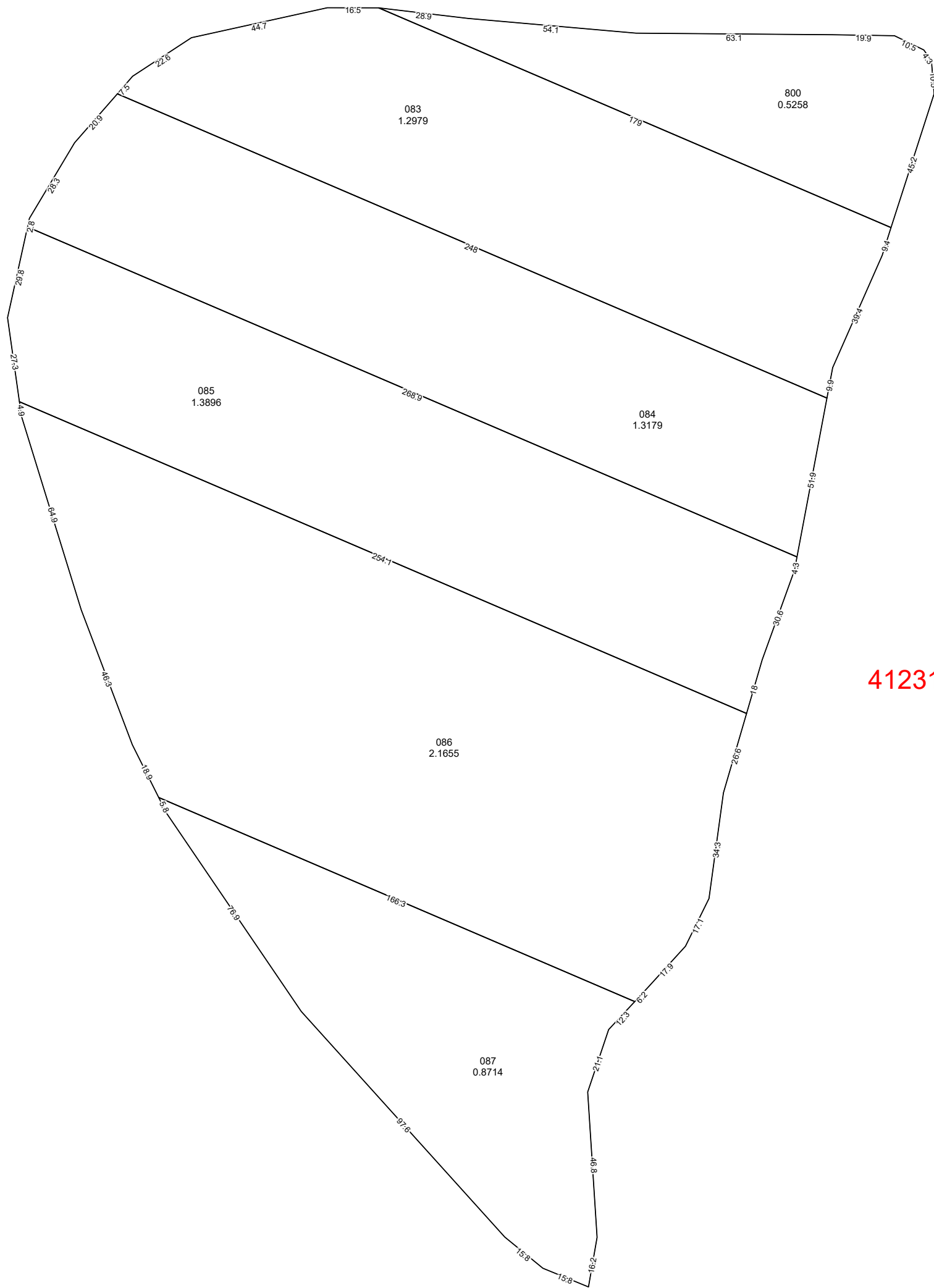



4123102

Directorul firmei _____/semnătura/
Specialistul licențiat _____/semnătura/
Planul cadastral întocmit de _____/semnătura/
Data tipării: 10.05.2022

Scara 1:2000

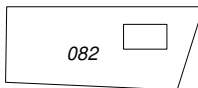
SEMNE CONVENȚIONALE

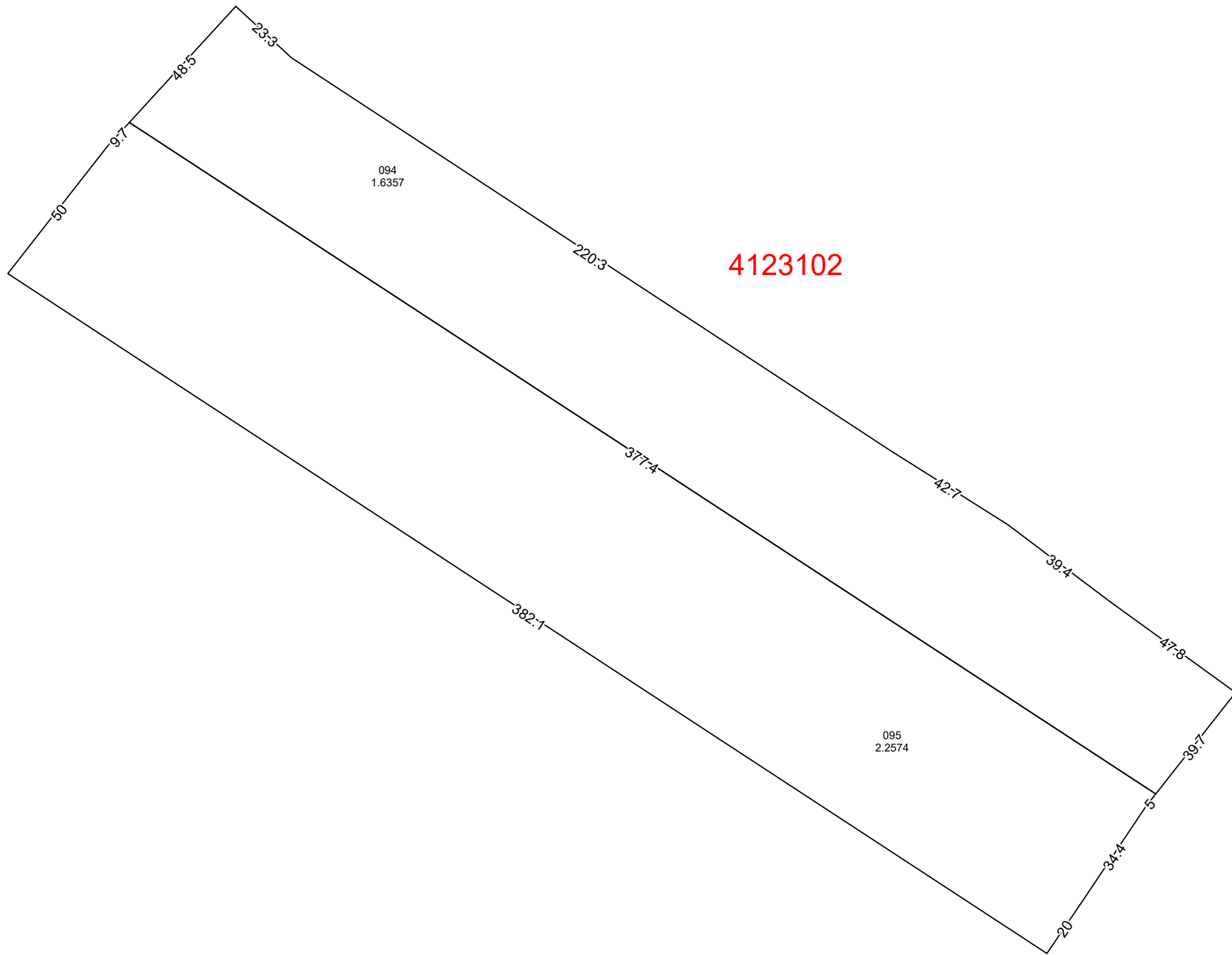

-  - numărul cadastral al parcelei
-   - numărul poștal
- 4123102** - codul cadastral al sectorul



Directorul firmei _____/semnătura/
Specialistul licențiat _____/semnătura/
Planul cadastral întocmit de _____/semnătura/
Data tipării: 10.05.2022

Scara 1:2000

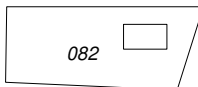
SEMNE CONVENȚIONALE

-  082 - numărul cadastral al parcelei
-  12  614a - numărul poștal
- 4123102 - codul cadastral al sectorul

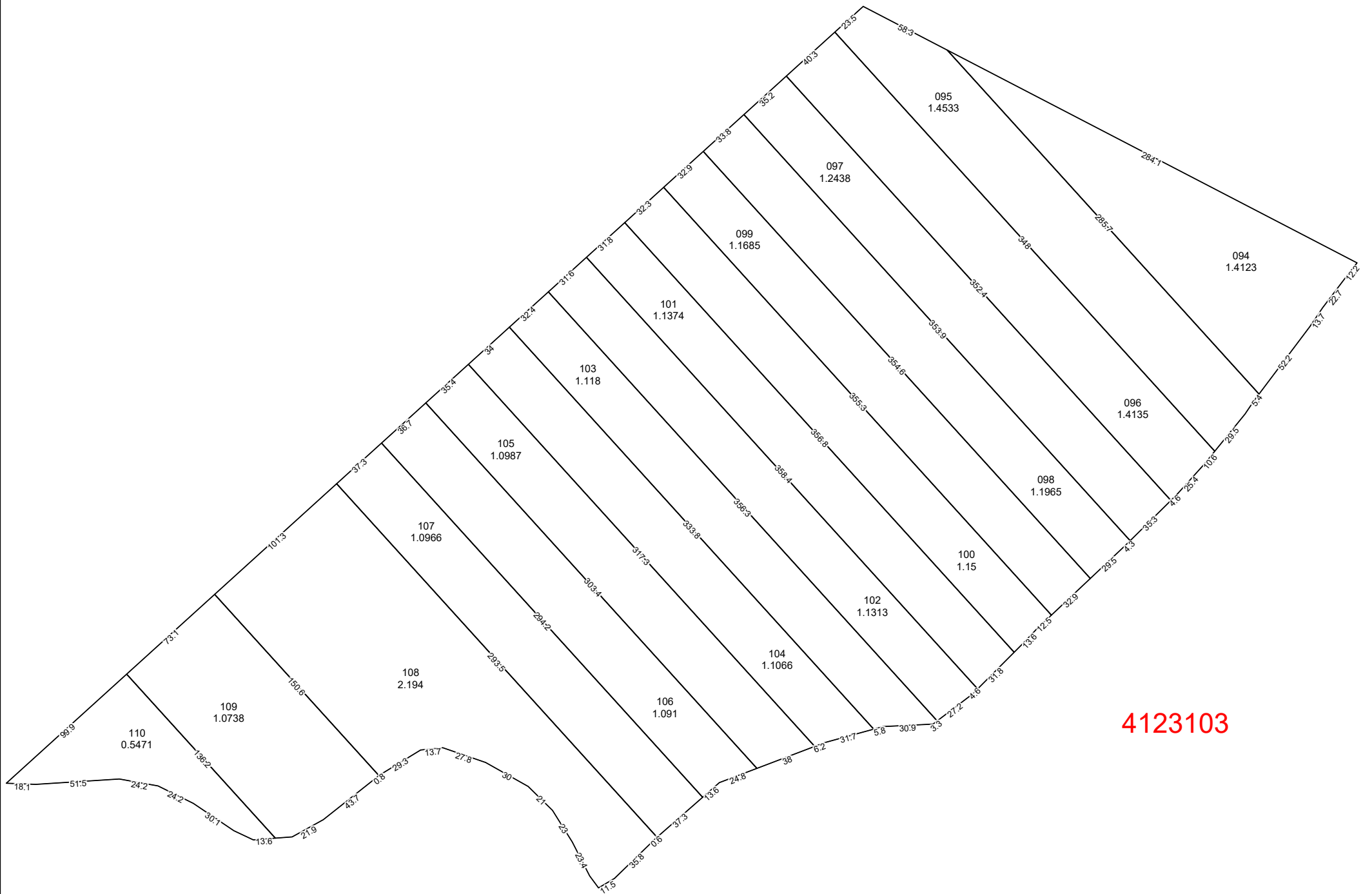



4123103

Directorul firmei _____/semnătura/
Specialistul licențiat _____/semnătura/
Planul cadastral întocmit de _____/semnătura/
Data tipării: 10.05.2022

Scara 1:2000

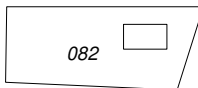

SEMNE CONVENȚIONALE

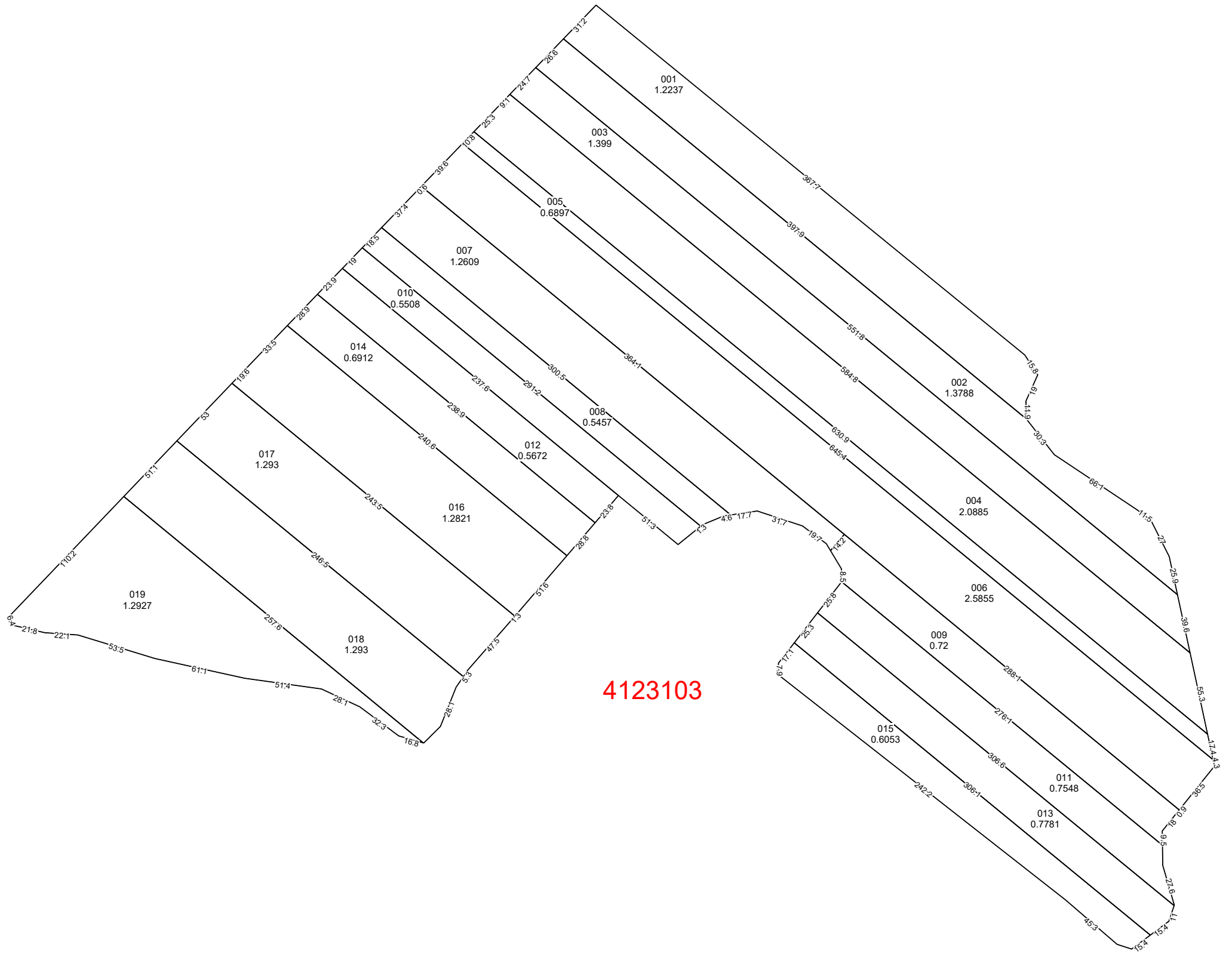
-  - numărul cadastral al parcelei
-   - numărul poștal
- 4123103** - codul cadastral al sectorului

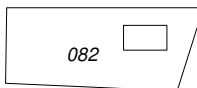

4123103

SEMNE CONVENȚIONALE

-  082 - numărul cadastral al parcelei
-  12  614a - numărul poștal
- 4123103 - codul cadastral al sectorului



Directorul firmei _____/semnătura/
Specialistul licențiat _____/semnătura/
Planul cadastral întocmit de _____/semnătura/
Data tipării: 10.05.2022

Scara 1:2000

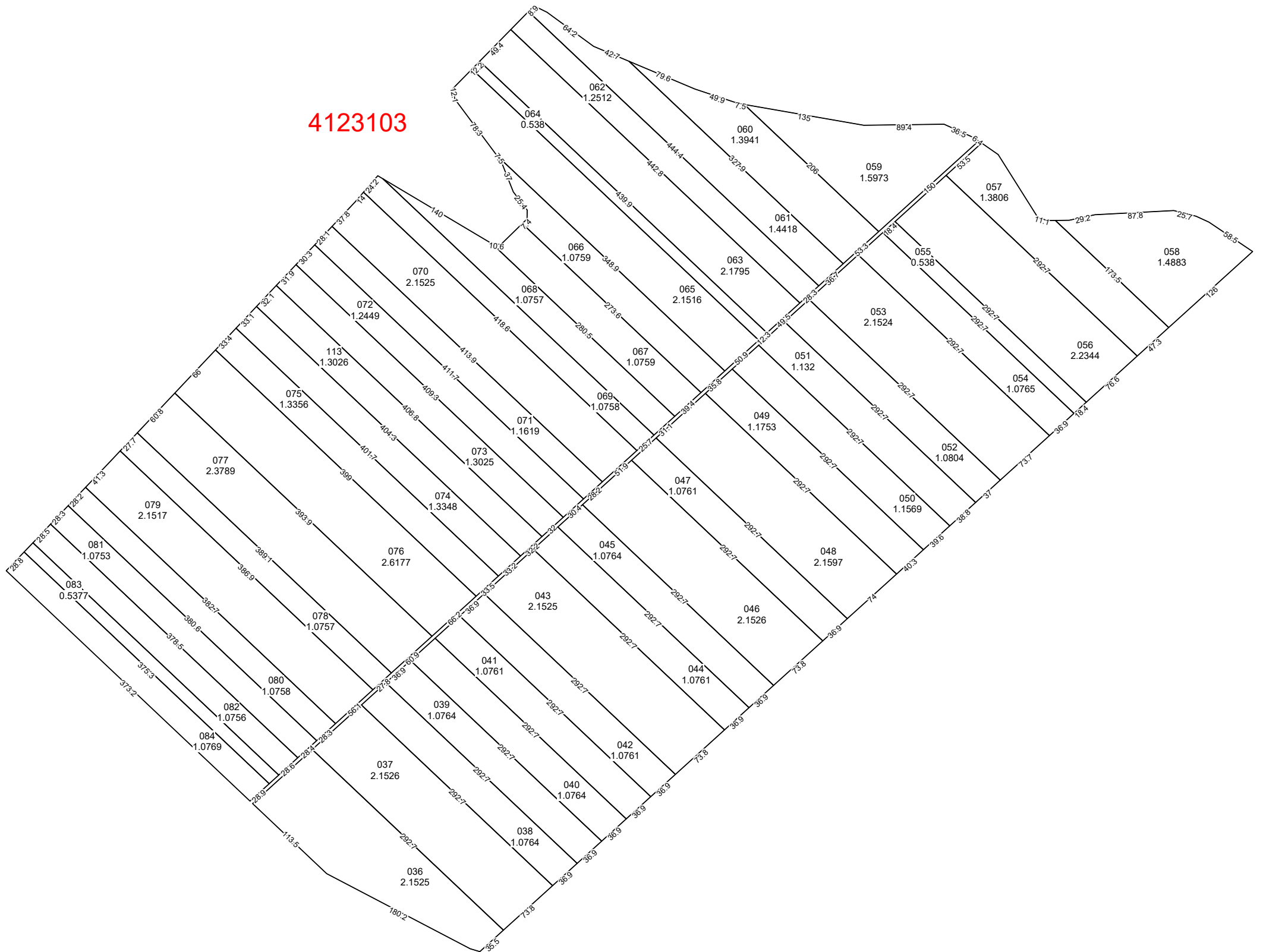
4123103

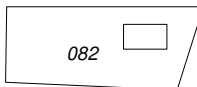

SEMNE CONVENȚIONALE

-  - numărul cadastral al parcelei
-   - numărul poștal
- 4123103** - codul cadastral al sectorul



Directorul firmei _____/semnătura/
Specialistul licențiat _____/semnătura/
Planul cadastral întocmit de _____/semnătura/
Data tipării: 10.05.2022

Scara 1:2000

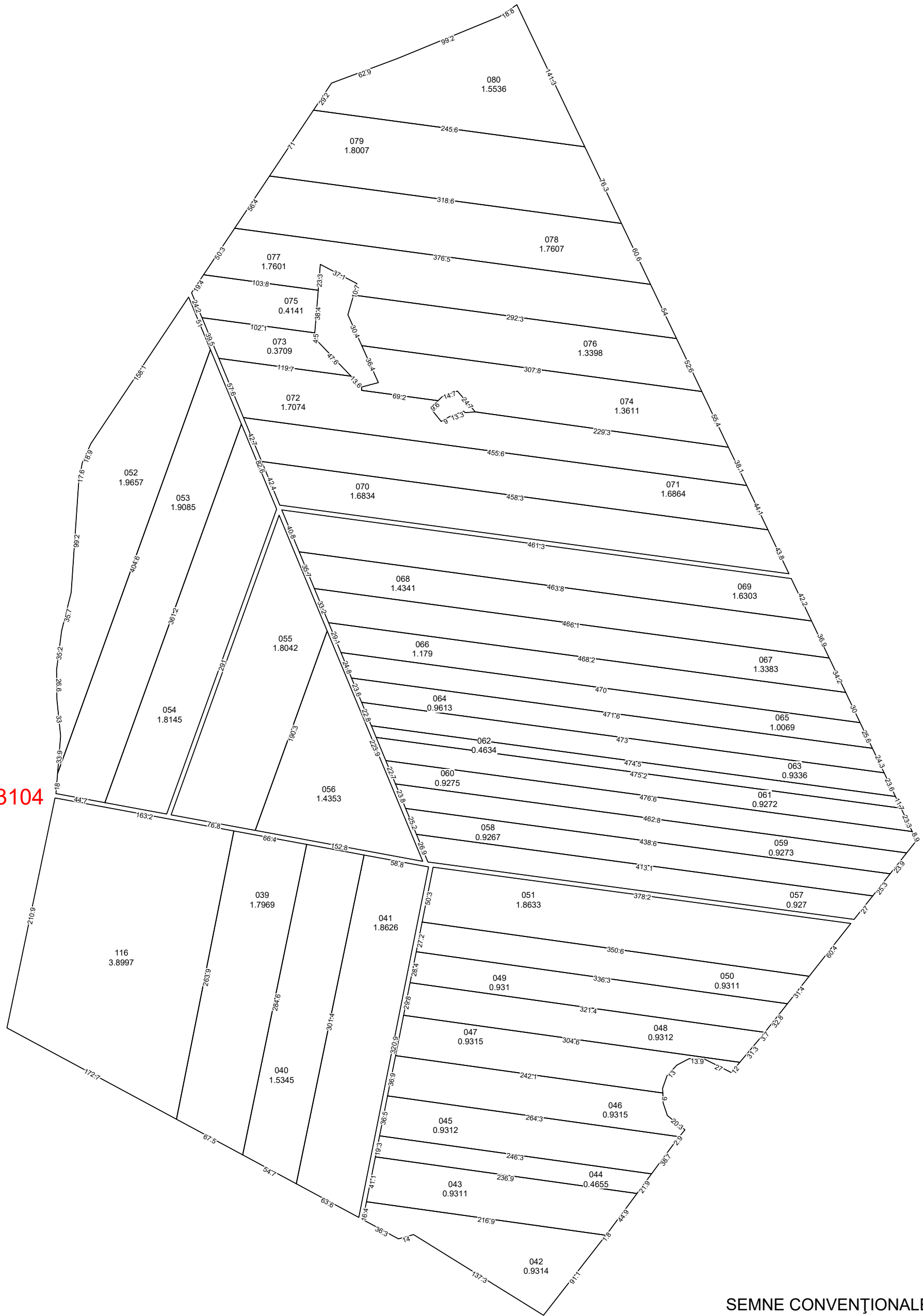
4123104

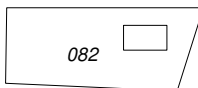

SEMNE CONVENȚIONALE

-  - numărul cadastral al parcelei
-   - numărul poștal
- 4123104** - codul cadastral al sectorul

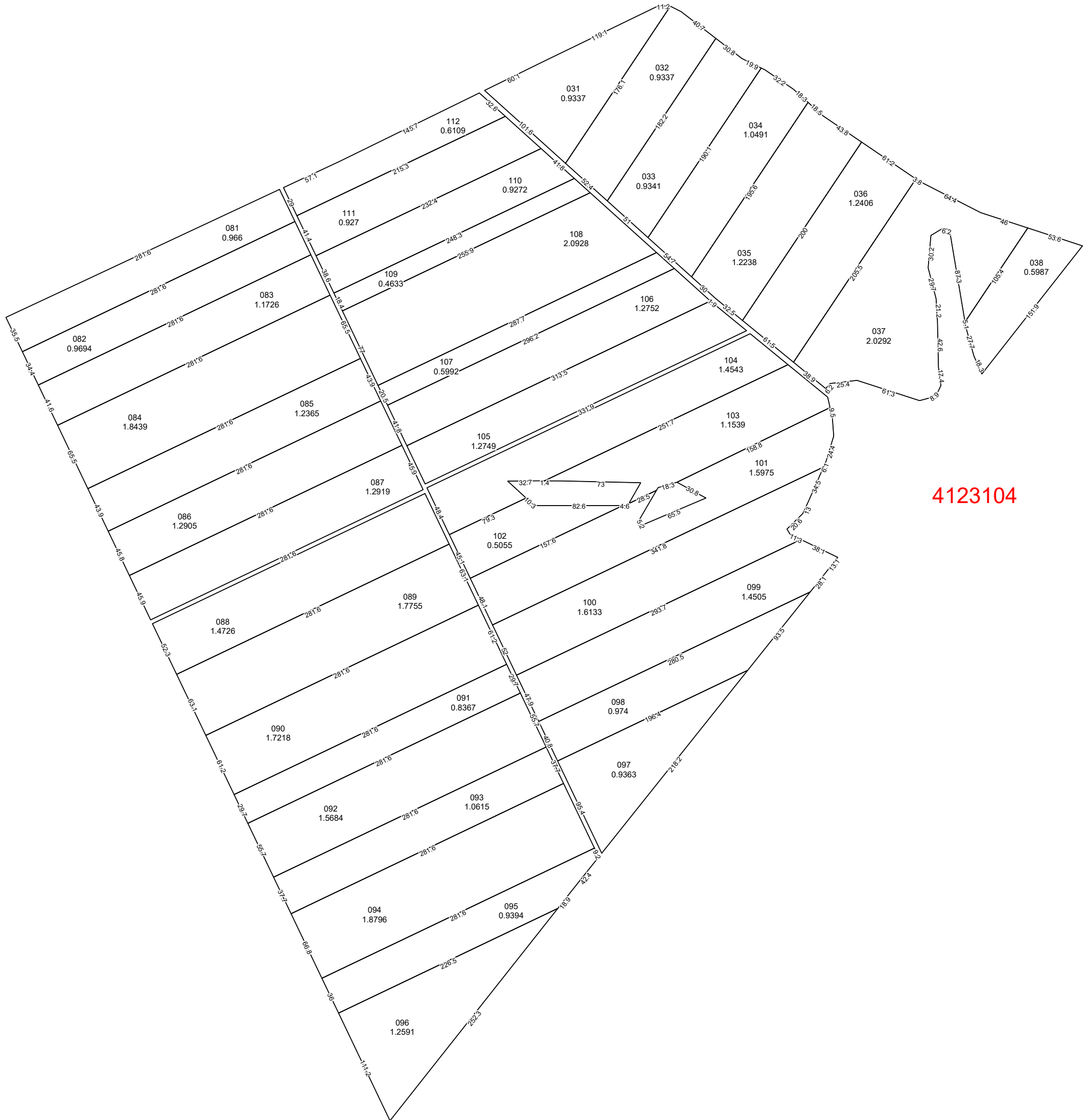

Directorul firmei _____/semnătura/
Specialistul licențiat _____/semnătura/
Planul cadastral întocmit de _____/semnătura/
Data tipării: 10.05.2022

Scara 1:2000

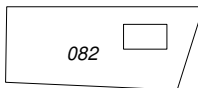

4123104

SEMNE CONVENȚIONALE

-  - numărul cadastral al parcelei
-   - numărul poștal
- 4123104** - codul cadastral al sectorului

Directorul firmei _____/semnătura/
Specialistul licențiat _____/semnătura/
Planul cadastral întocmit de _____/semnătura/
Data tipării: 10.05.2022

Scara 1:2000