

PLANUL GEOMETRIC 5511306, 310

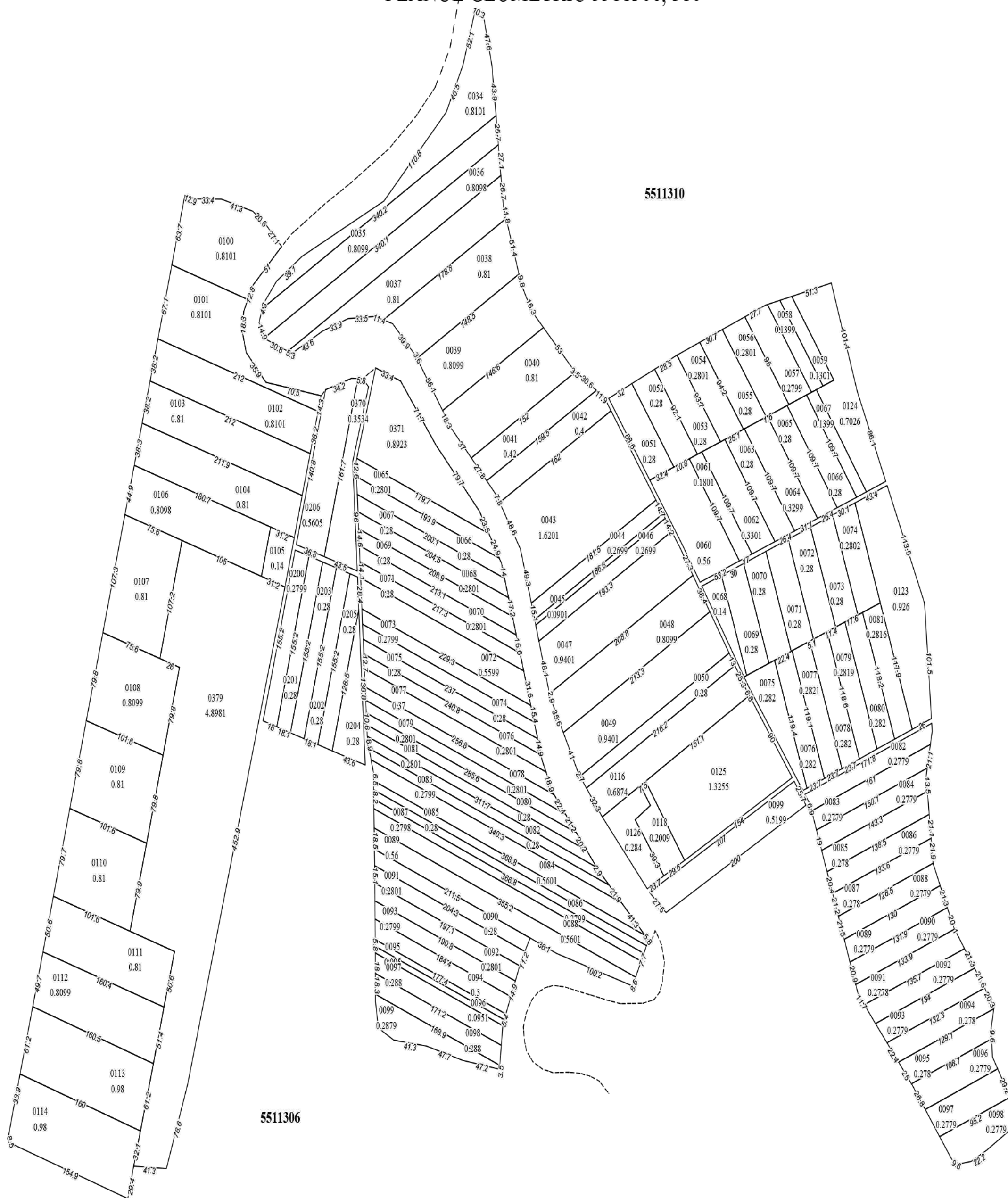

SEMNE CONVENŢIONALE

082 - numărul cadastral al parcelei

12 614a - numărul poştal

5511101 - codul cadastral al sectorului

Managerul PİEF _____/semnătura/

Planul cadastral întocmit de _____/semnătura/

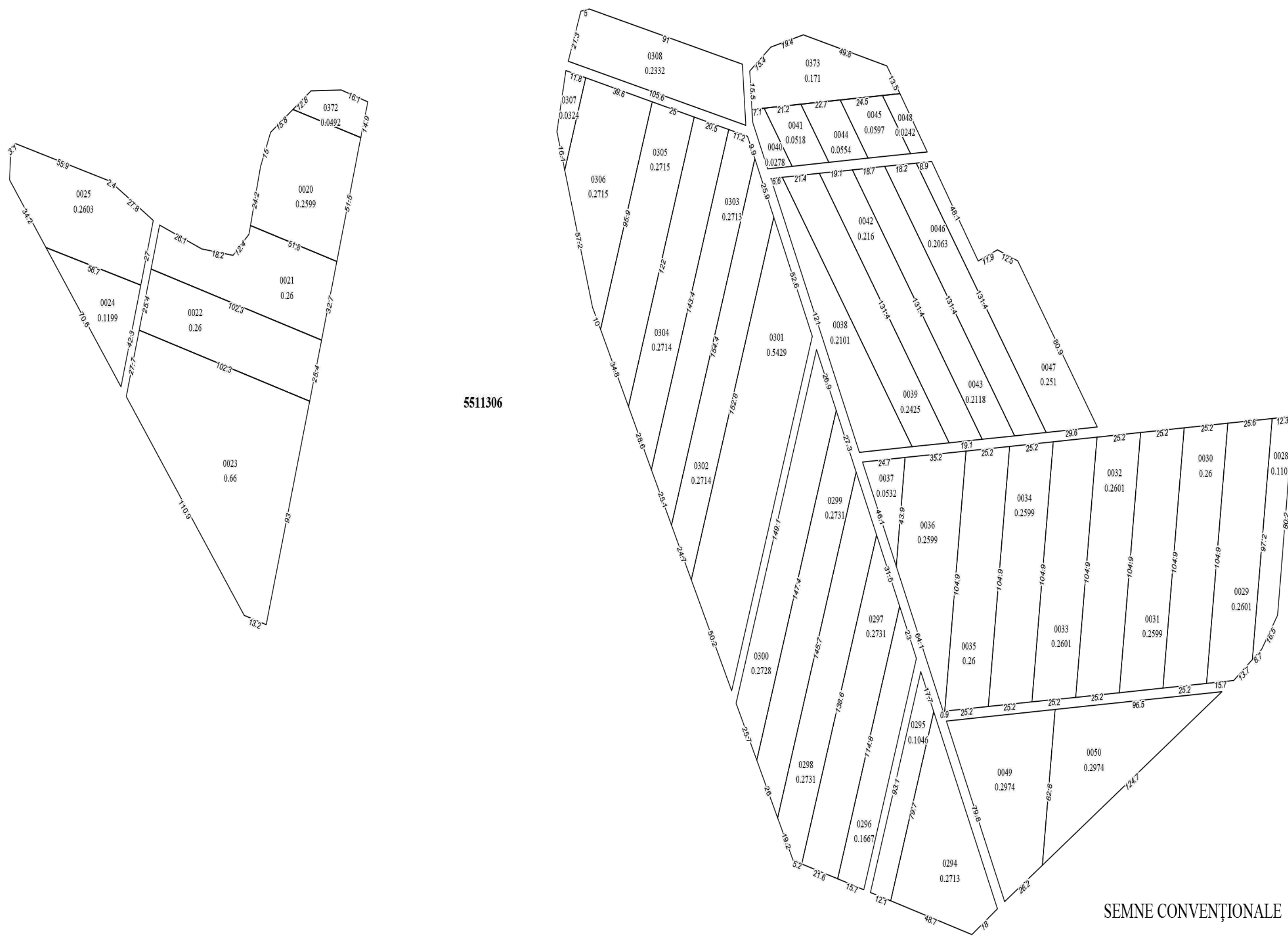

Data tipării: 20.02.2024

Scara 1:2000

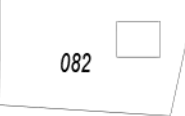

5511306

SEMNE CONVENŢIONALE

-  082 - numărul cadastral al parcelei
-  12  614a - numărul poştal
- 5511101 - codul cadastral al sectorului

Managerul PÎEF _____ /semnătura/
Planul cadastral întocmit de _____ /semnătura/
Data tipării: 20.02.2024

Scara 1:2000

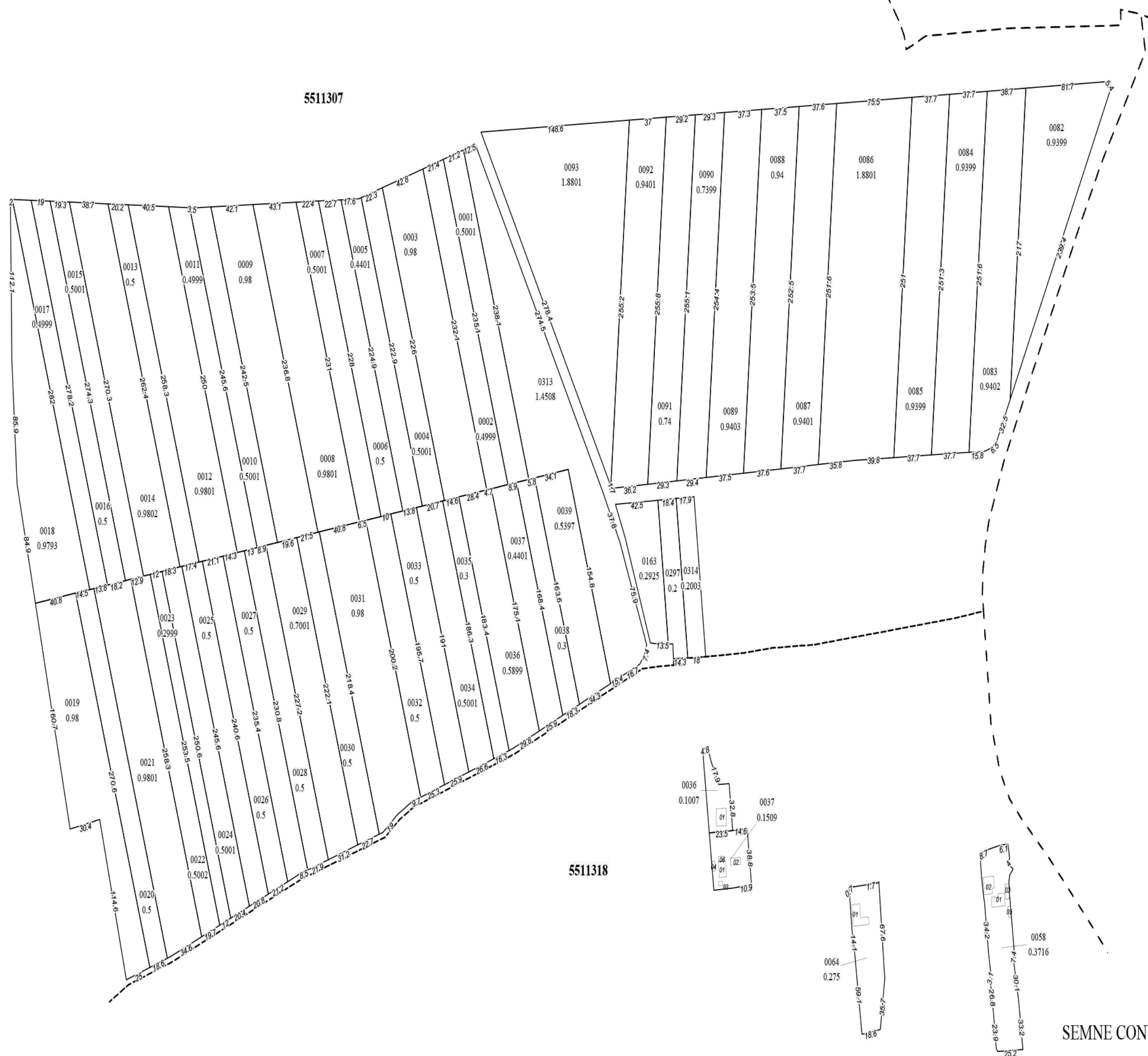

Managerul PÎEF _____/semnătura/

Planul cadastral întocmit de _____/semnătura/

Data tipării: 20.02.2024

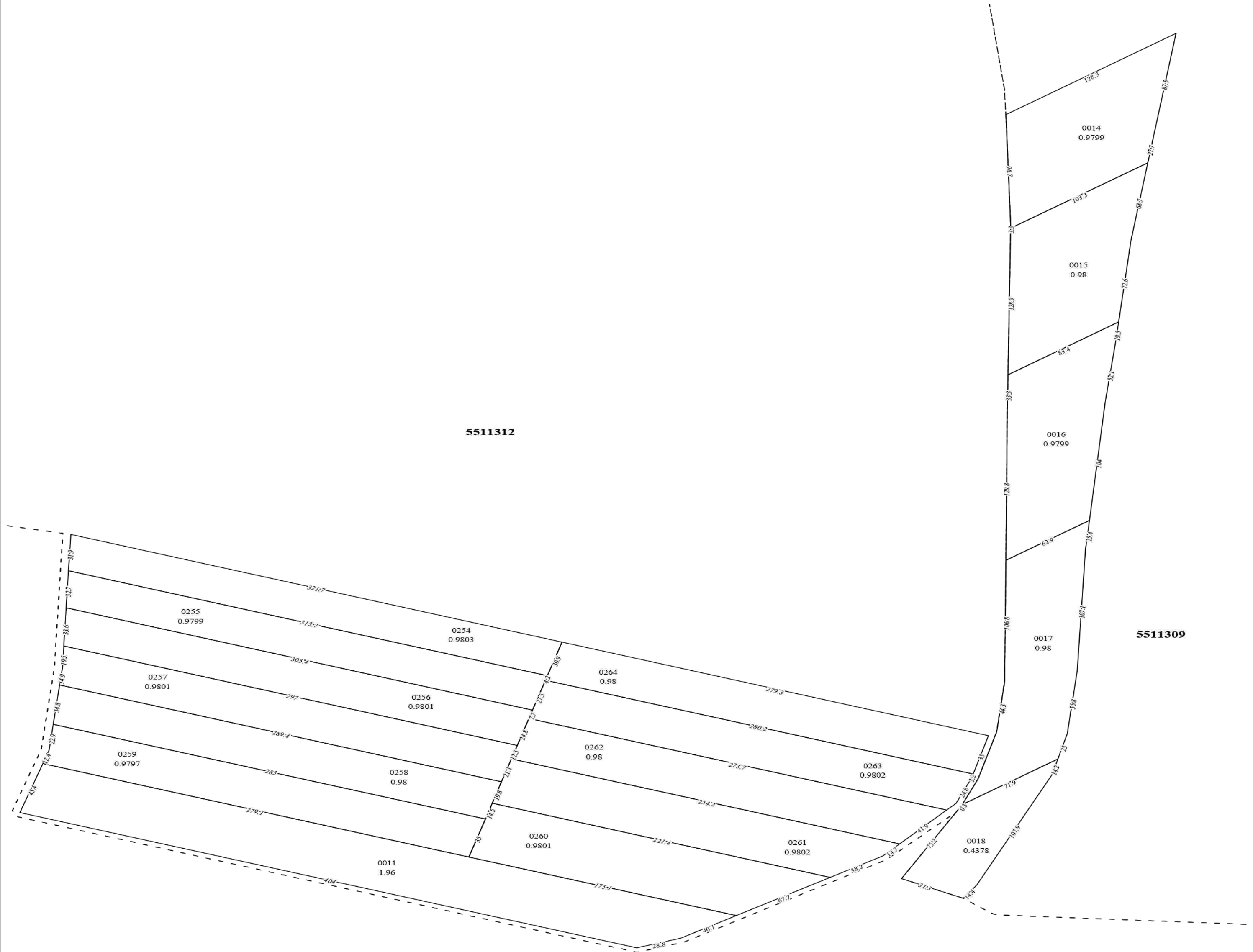

Scara 1:2000



Managerul PÎEF _____/semnătura/
Planul cadastral întocmit de _____/semnătura/
Data tipării: 20.02.2024

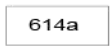

Scara 1:2000

SEMNE CONVENŢIONALE

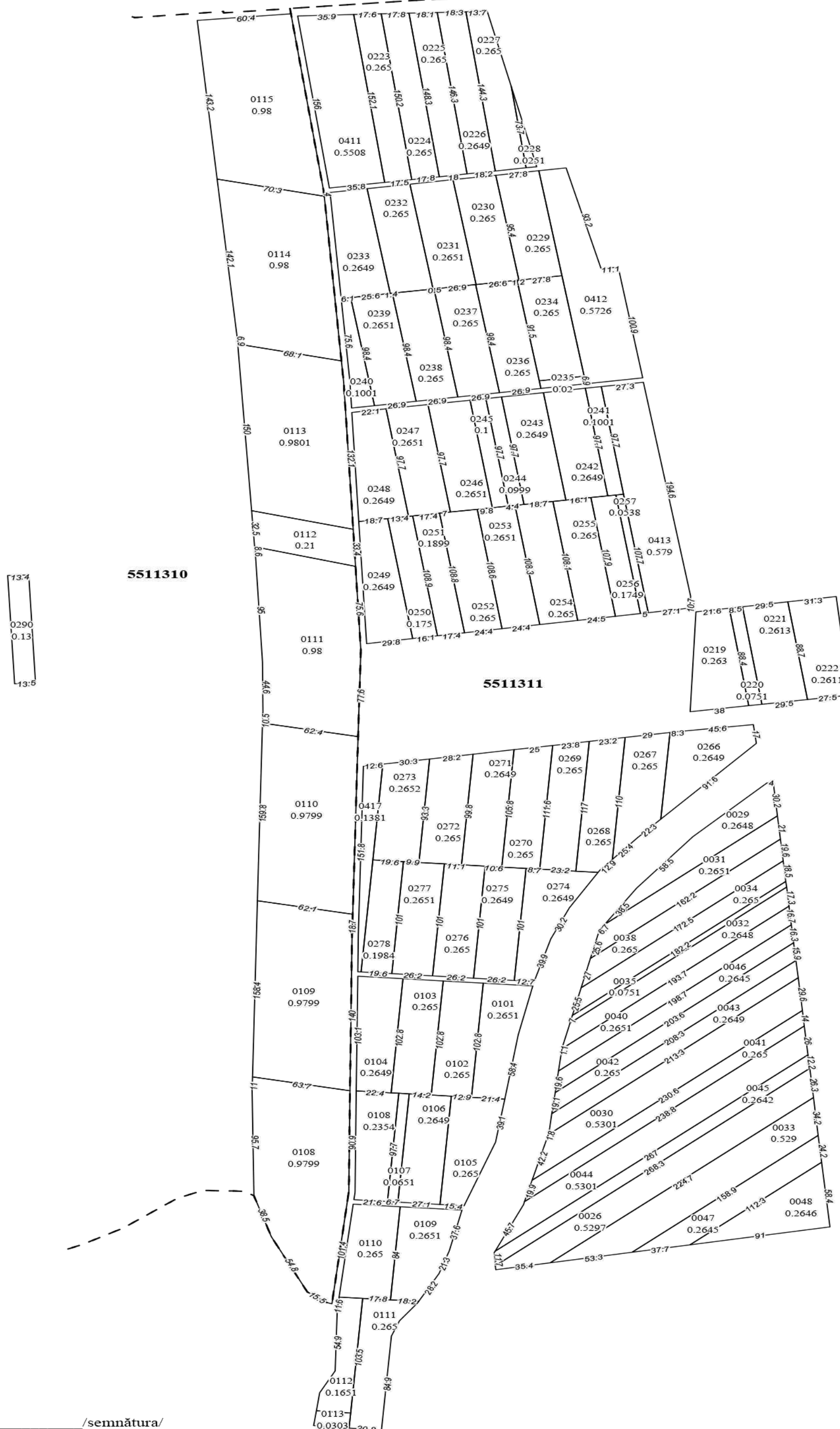
-  082 - numărul cadastral al parcelei
-  12  614a - numărul poştal
- 5511101 - codul cadastral al sectorul



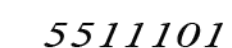

SEMNE CONVENŢIONALE

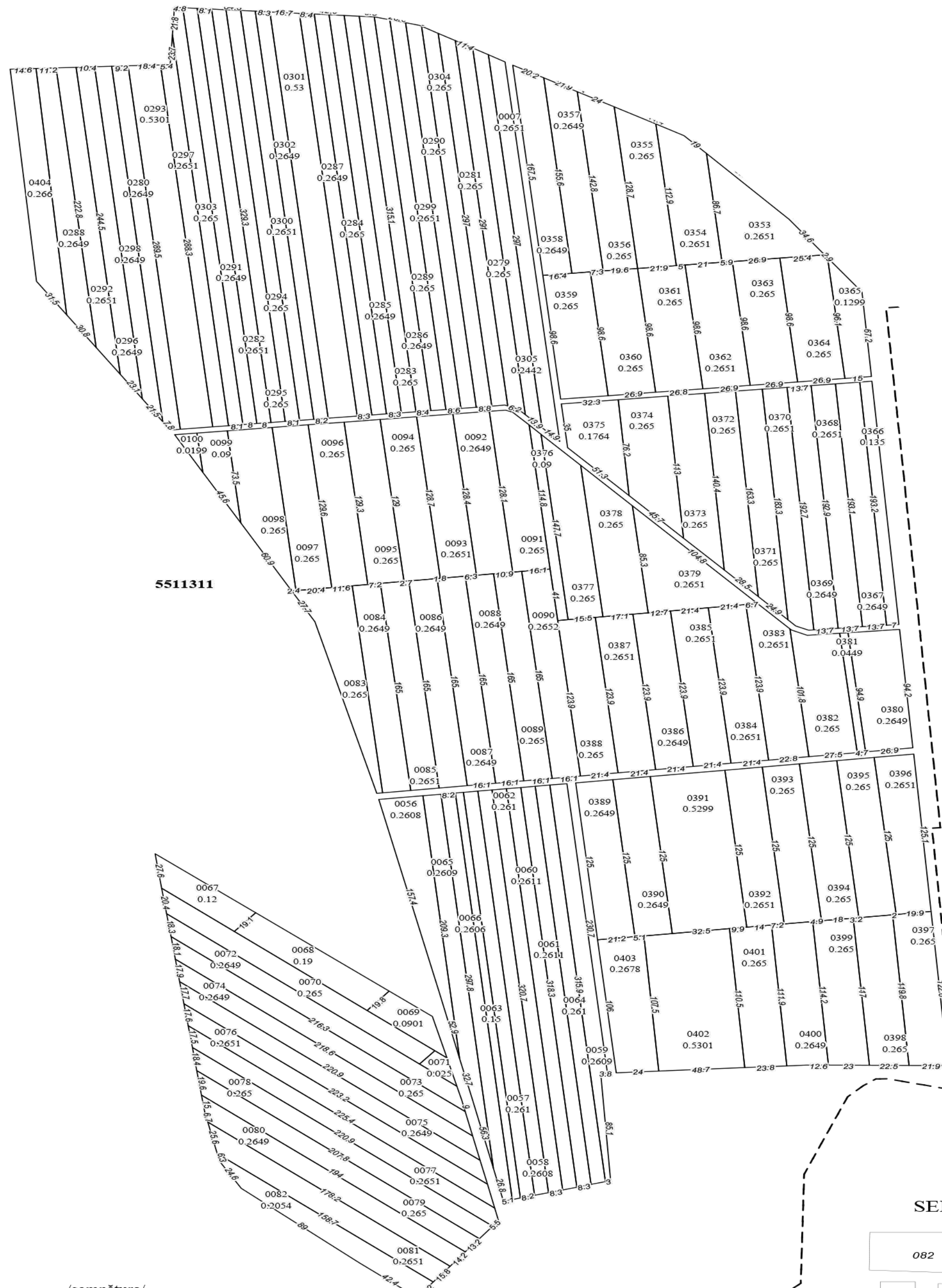
-  - numărul cadastral al parcelei
-   - numărul poştal
-  - codul cadastral al sectorul



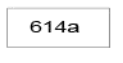

5511311

SEMNE CONVENŢIONALE

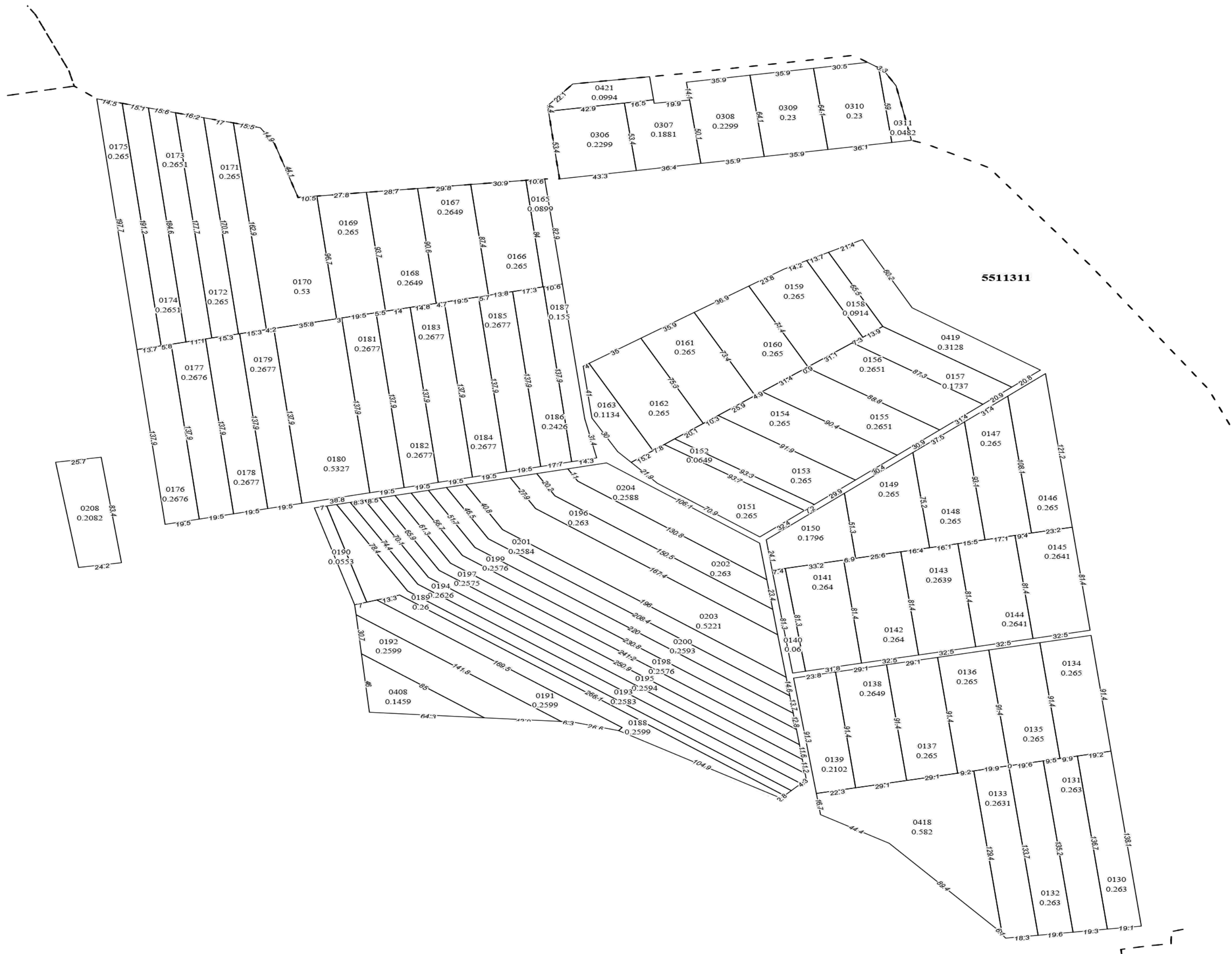
-  - numărul cadastral al parcelei
-   - numărul poştal
- 5511101 - codul cadastral al sectorul



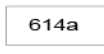
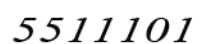

SEMNE CONVENŢIONALE

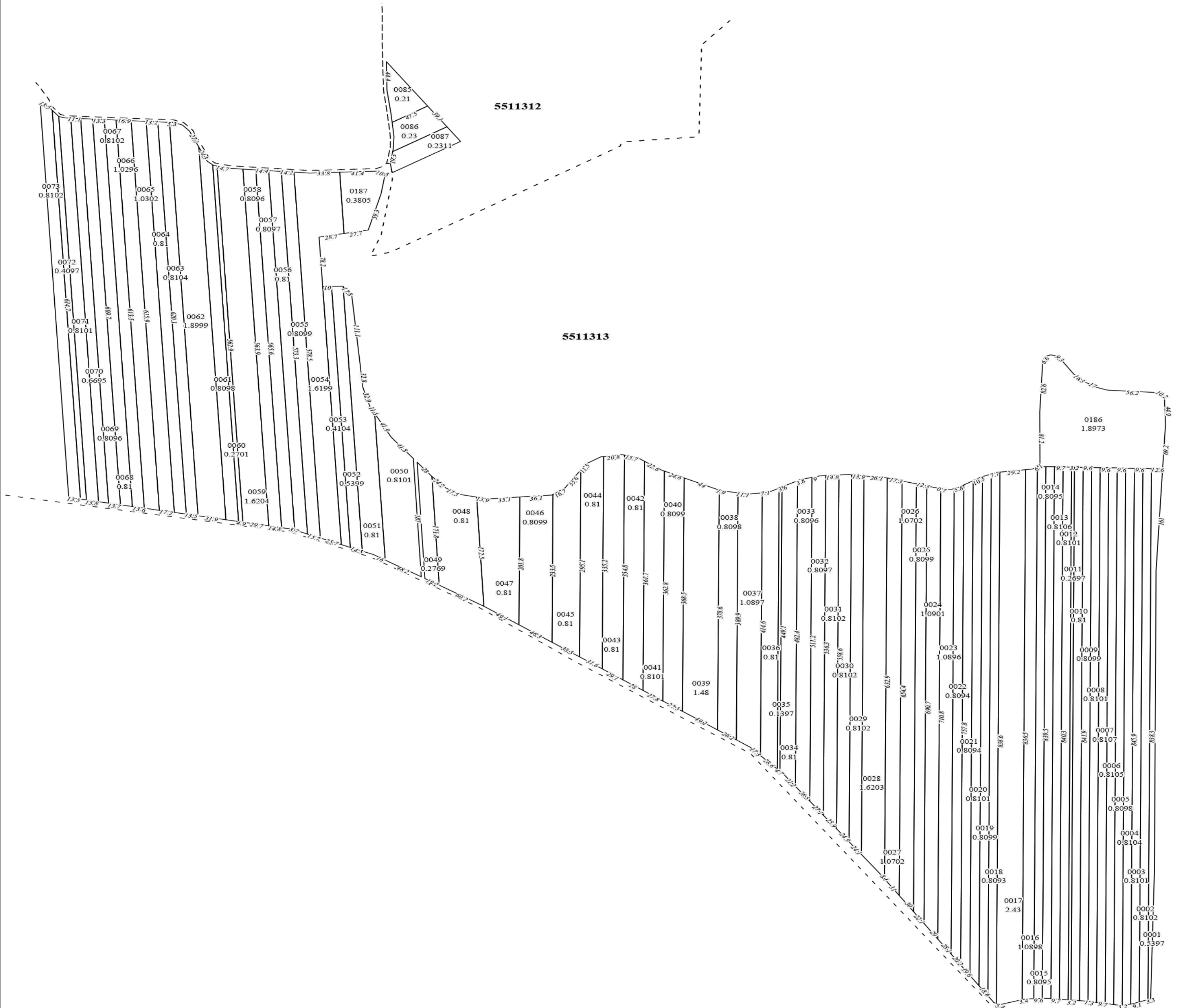
-  - numărul cadastral al parcelei
-   - numărul poştal
-  - codul cadastral al sectorul



SEMNE CONVENŢIONALE

-  - numărul cadastral al parcelei
-  - numărul poştal
-  - codul cadastral al sectorul