

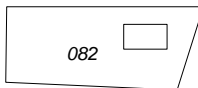

2330101

Directorul firmei \_\_\_\_\_/semnătura/  
Specialistul licențiat \_\_\_\_\_/semnătura/  
Planul cadastral întocmit de \_\_\_\_\_/semnătura/  
Data tipării: 17.05.2023

Scara 1:2000

SEMNE CONVENȚIONALE

-  - numărul cadastral al parcelei
-   - numărul poștal
- 2330101** - codul cadastral al sectorul

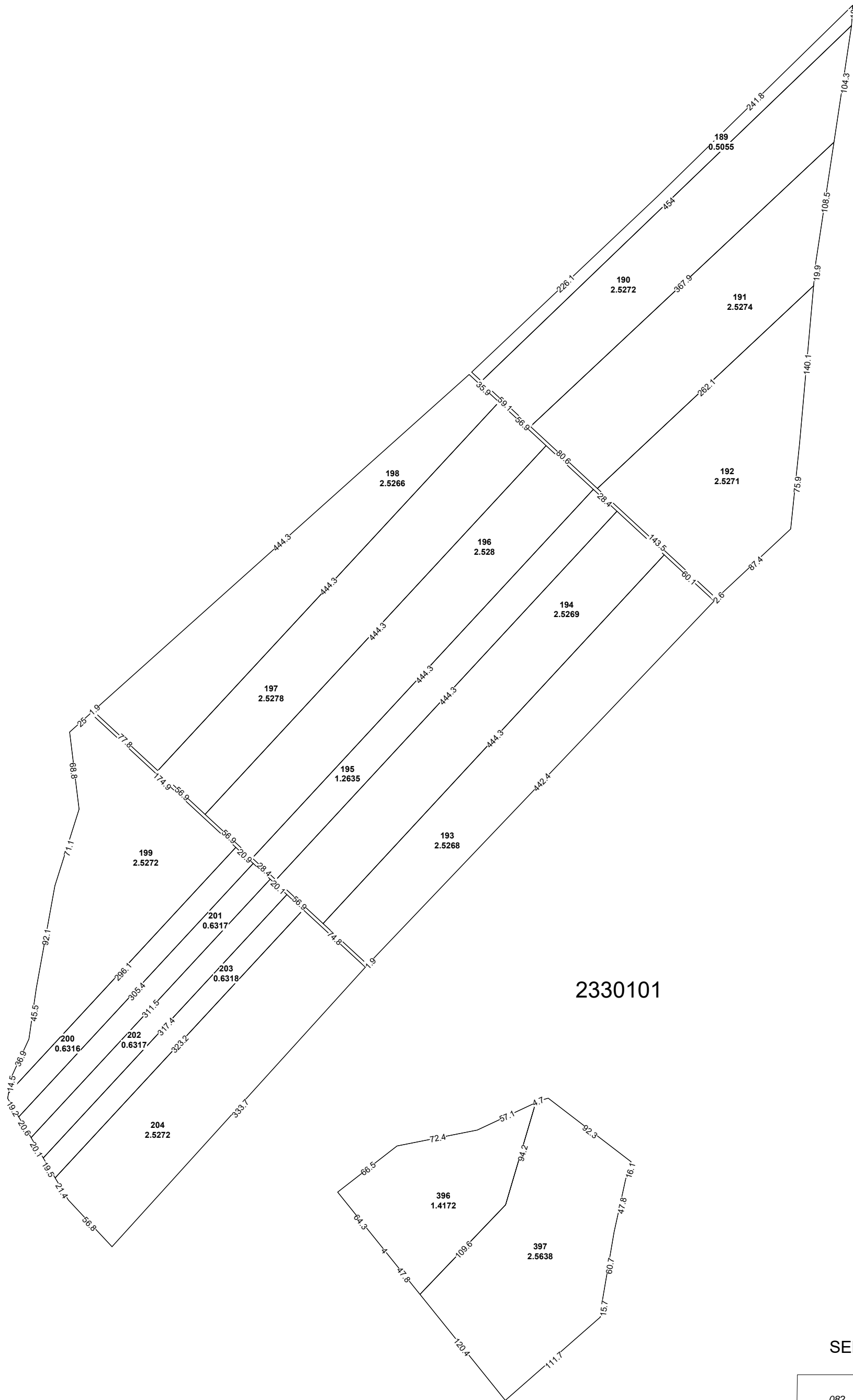





2330101

Directorul firmei \_\_\_\_\_/semnătura/  
Specialistul licențiat \_\_\_\_\_/semnătura/  
Planul cadastral întocmit de \_\_\_\_\_/semnătura/  
Data tipării: 17.05.2023

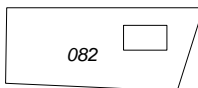
Scara 1:2000

SEMNE CONVENȚIONALE

-  - numărul cadastral al parcelei
-   - numărul poștal
-  - codul cadastral al sectorul

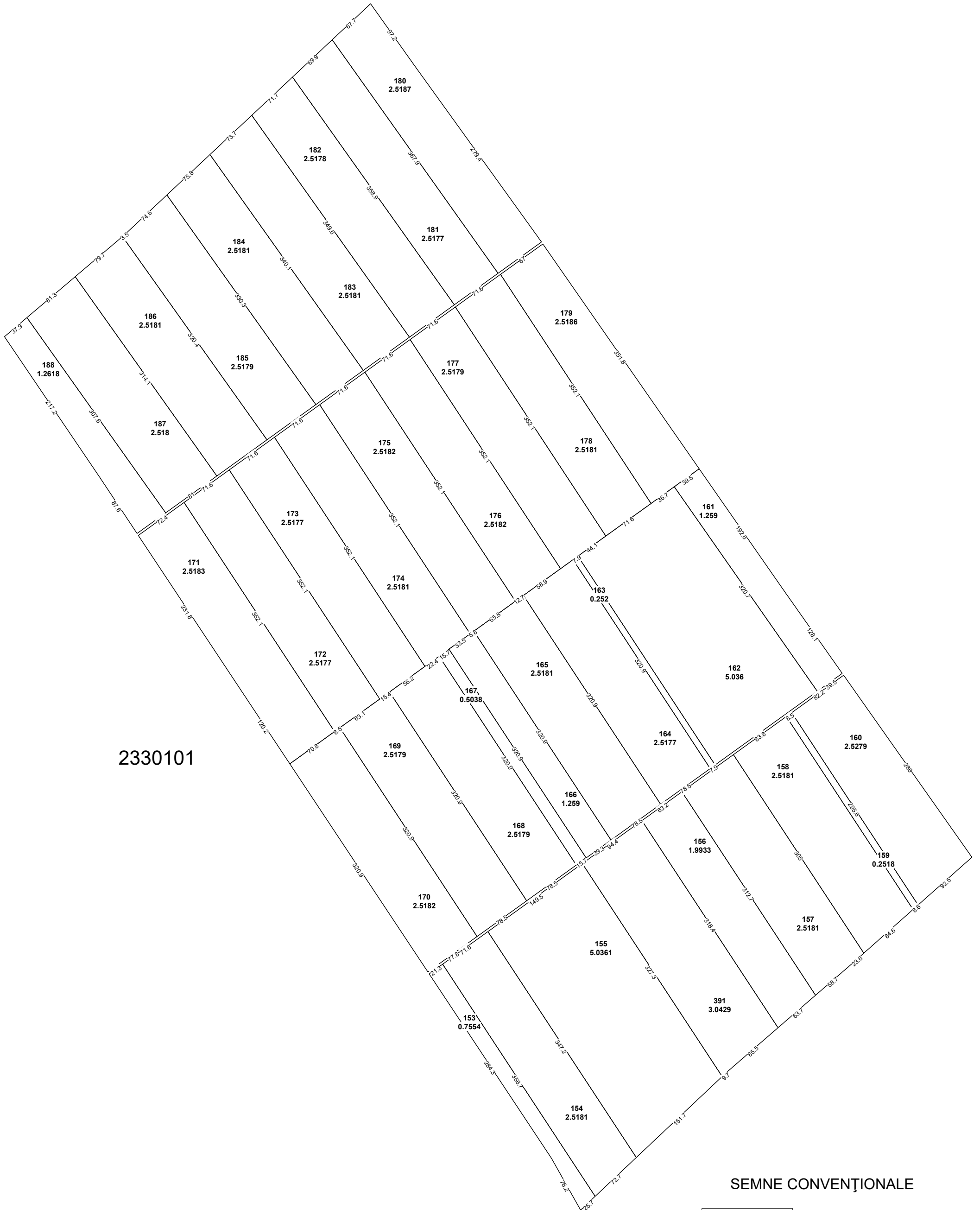



2330101

Directorul firmei \_\_\_\_\_/semnătura/  
Specialistul licențiat \_\_\_\_\_/semnătura/  
Planul cadastral întocmit de \_\_\_\_\_/semnătura/  
Data tipării: 17.05.2023

Scara 1:2000

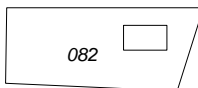

SEMNE CONVENȚIONALE

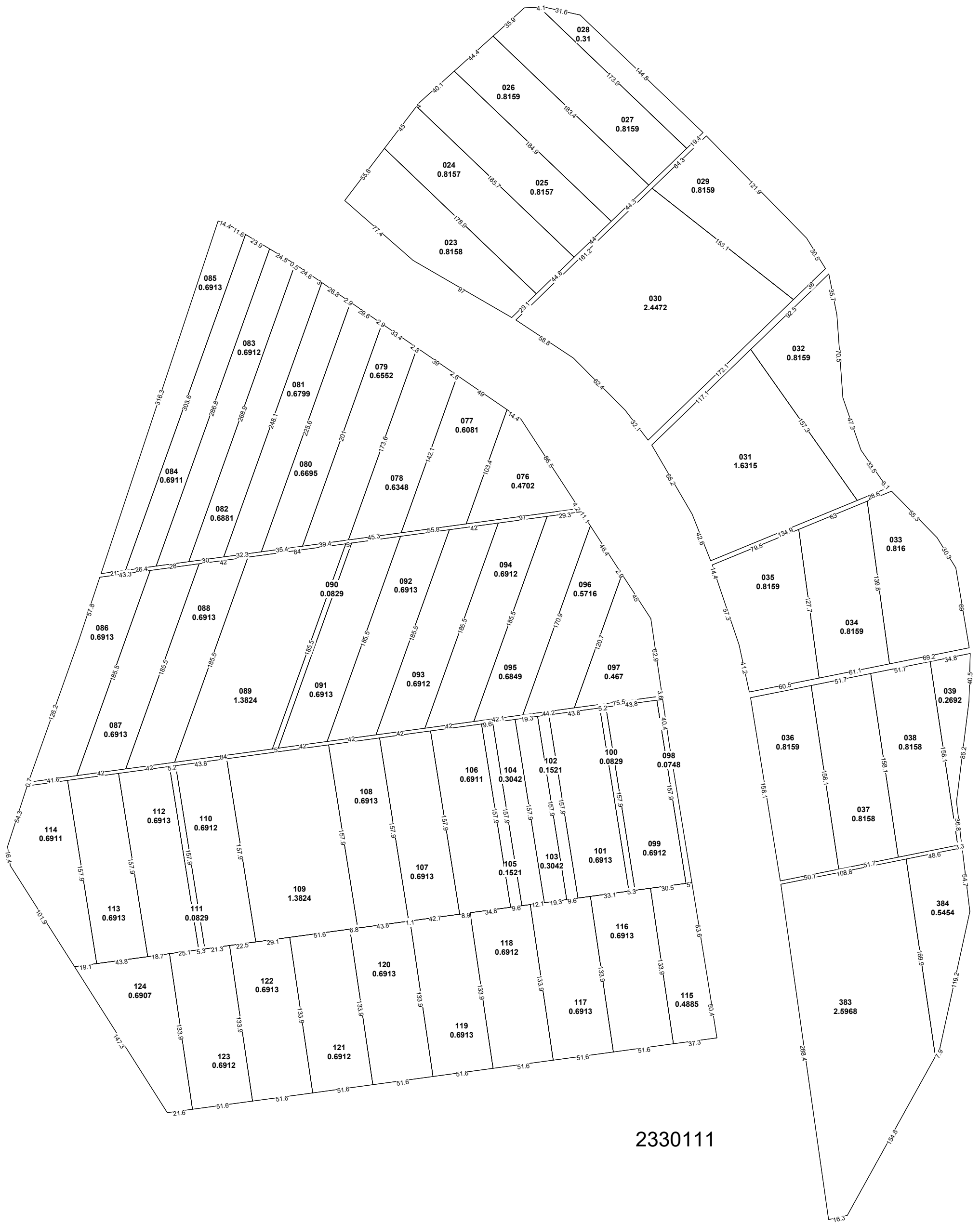
-  082 - numărul cadastral al parcelei
-  12  614a - numărul poștal
- 2330101 - codul cadastral al sectorul

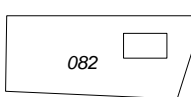
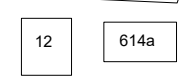

2330111

SEMNE CONVENȚIONALE

-  - numărul cadastral al parcelei
-  - numărul poștal
-  - codul cadastral al sectorul

Directorul firmei \_\_\_\_\_/semnătura/  
Specialistul licențiat \_\_\_\_\_/semnătura/  
Planul cadastral întocmit de \_\_\_\_\_/semnătura/  
Data tipării: 17.05.2023

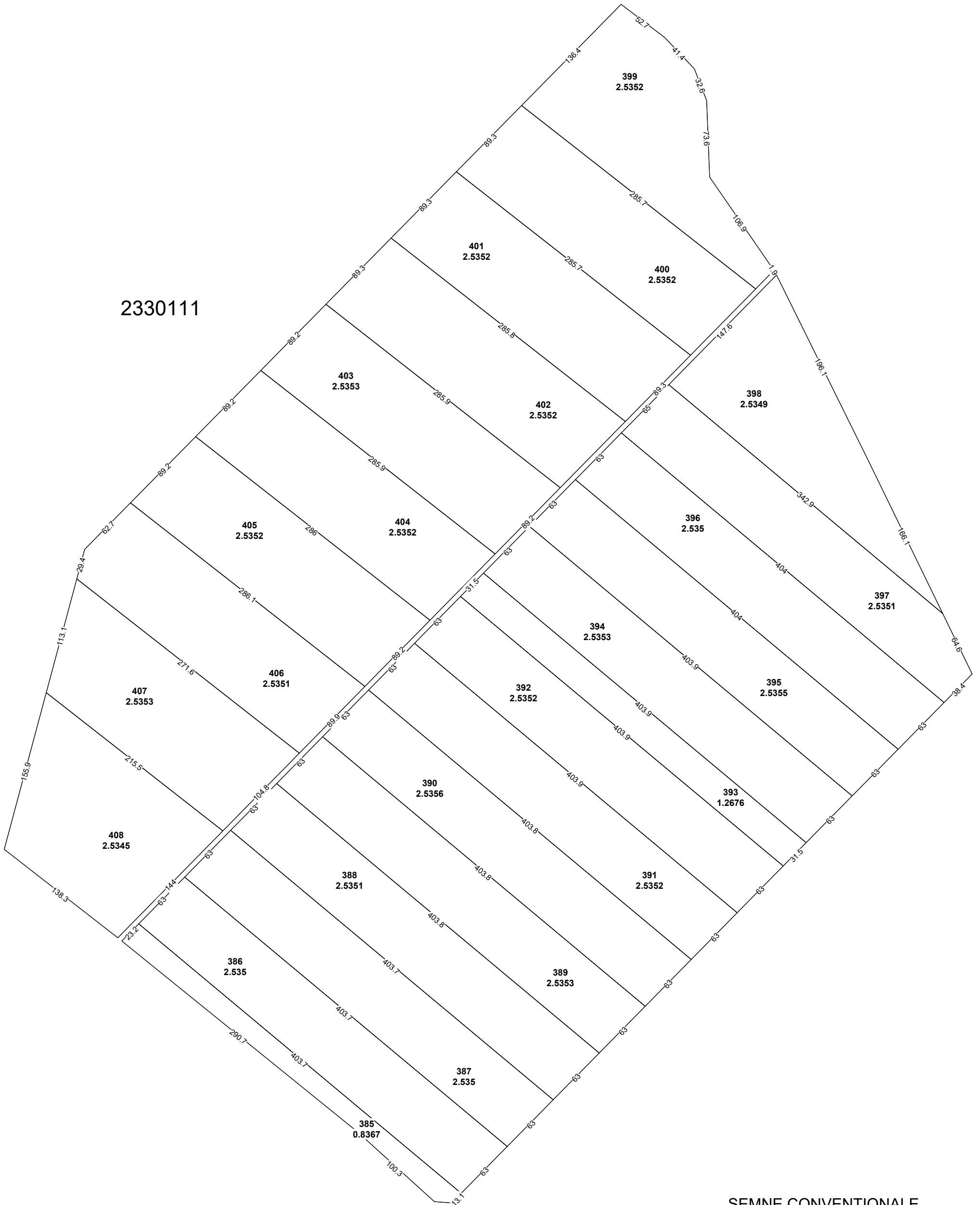

Scara 1:2000



Directorul firmei \_\_\_\_\_/semnătura/  
Specialistul licențiat \_\_\_\_\_/semnătura/  
Planul cadastral întocmit de \_\_\_\_\_/semnătura/  
Data tipării: 17.05.2023

Scara 1:2000

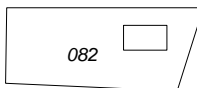
SEMNE CONVENȚIONALE

-  - numărul cadastral al parcelei
-   - numărul poștal
- 2330111** - codul cadastral al sectorul





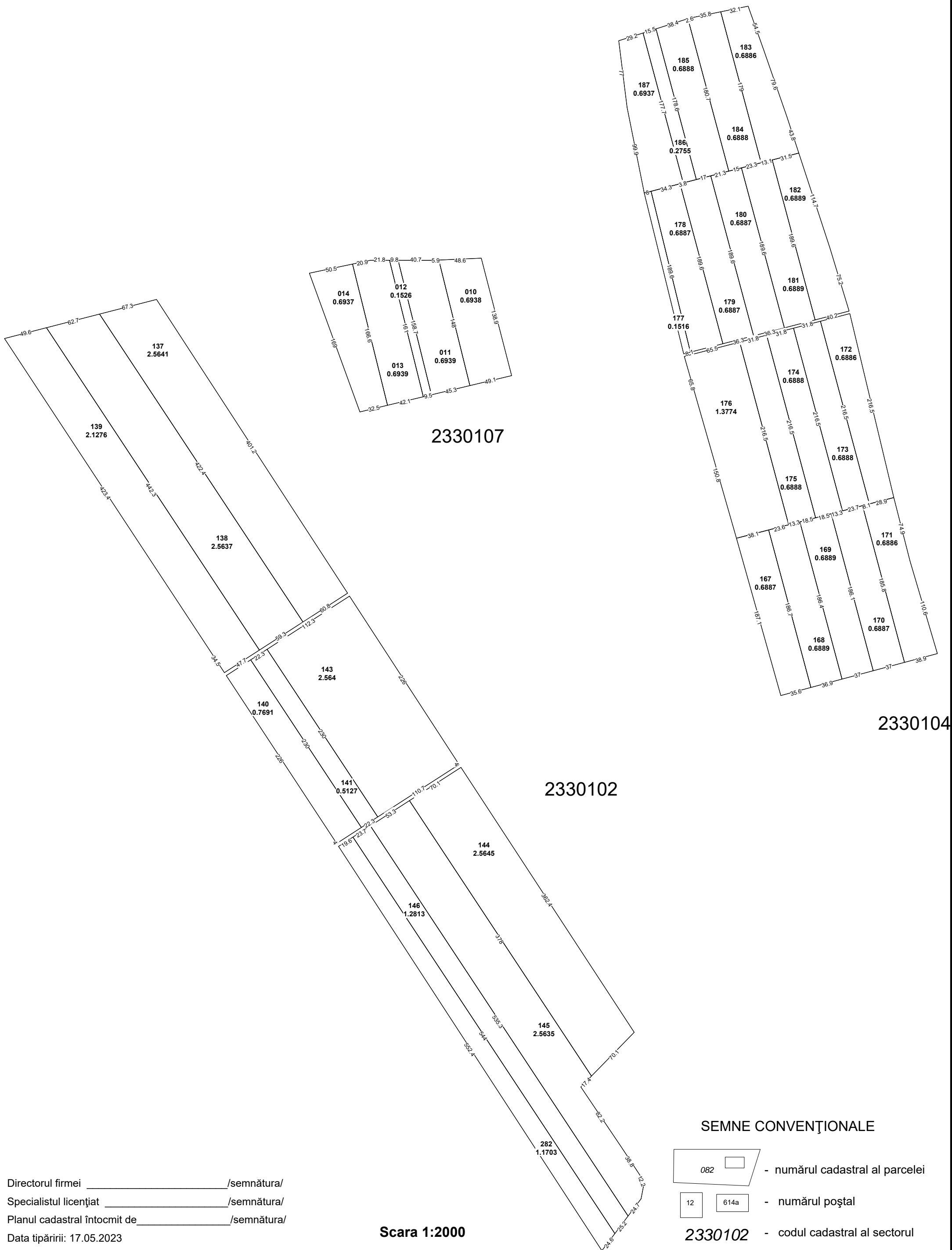

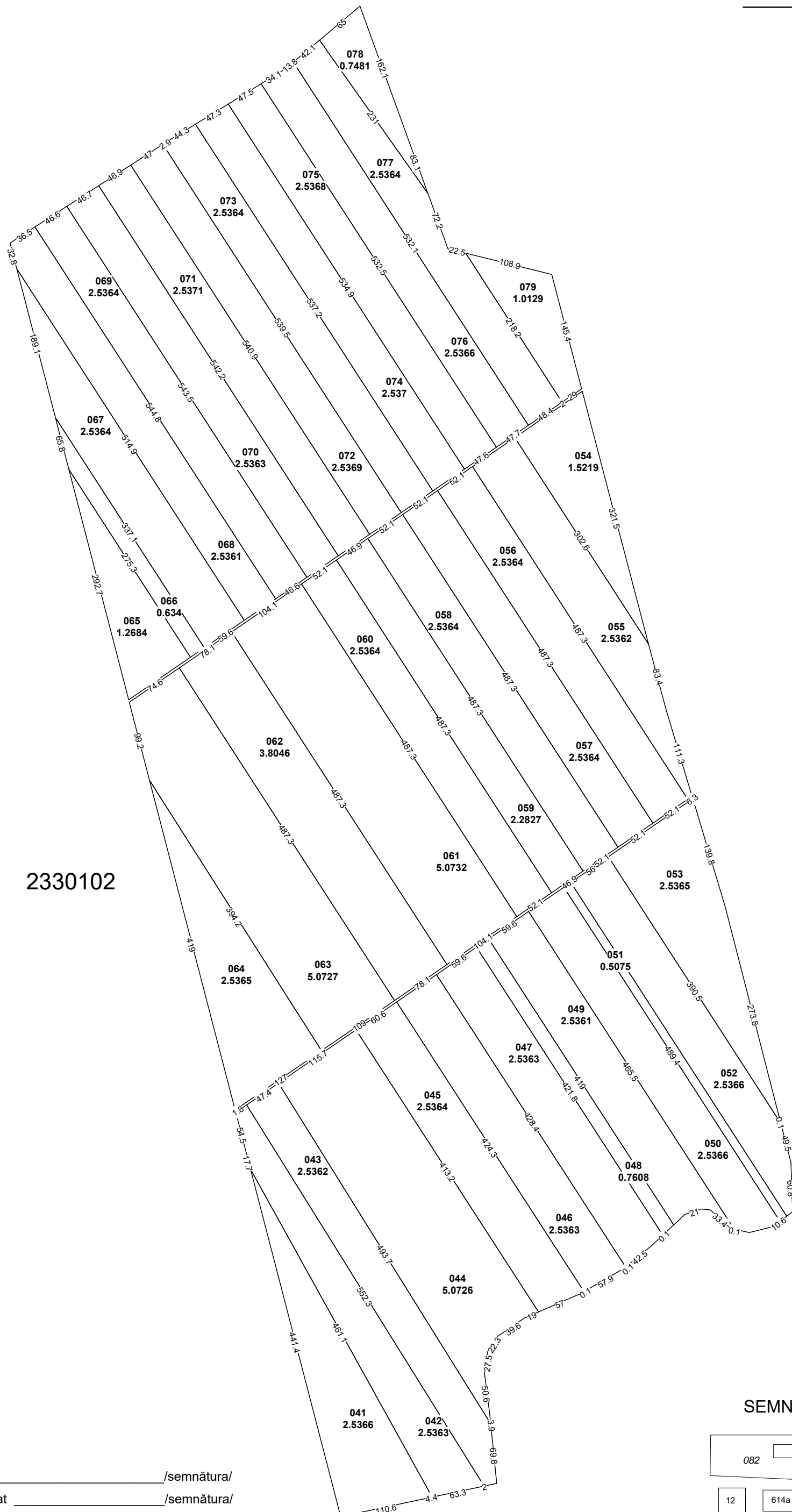



2330102

Directorul firmei \_\_\_\_\_/semnătura/  
Specialistul licențiat \_\_\_\_\_/semnătura/  
Planul cadastral întocmit de \_\_\_\_\_/semnătura/  
Data tipării: 17.05.2023

Scara 1:2000

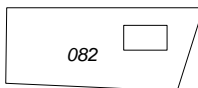

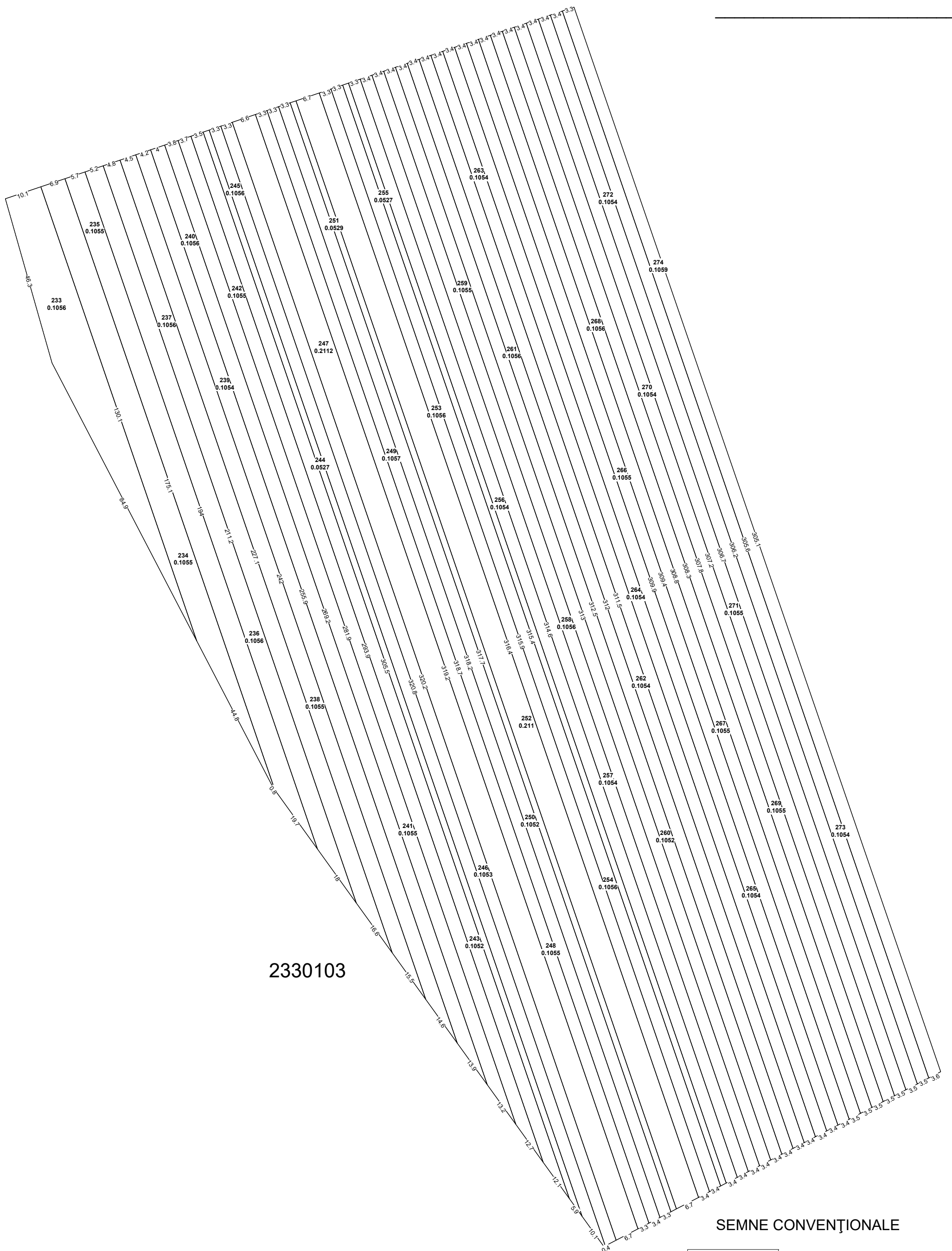

SEMNE CONVENȚIONALE

-  - numărul cadastral al parcelei
-   - numărul poștal
- 2330102** - codul cadastral al sectorul

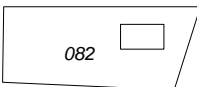

2330103

SEMNE CONVENȚIONALE

-  - numărul cadastral al parcelei
-   - numărul poștal
-  - codul cadastral al sectorul

Directorul firmei \_\_\_\_\_/semnătura/

Specialistul licențiat \_\_\_\_\_/semnătura/

Planul cadastral întocmit de \_\_\_\_\_/semnătura/

Data tipării: 17.05.2023

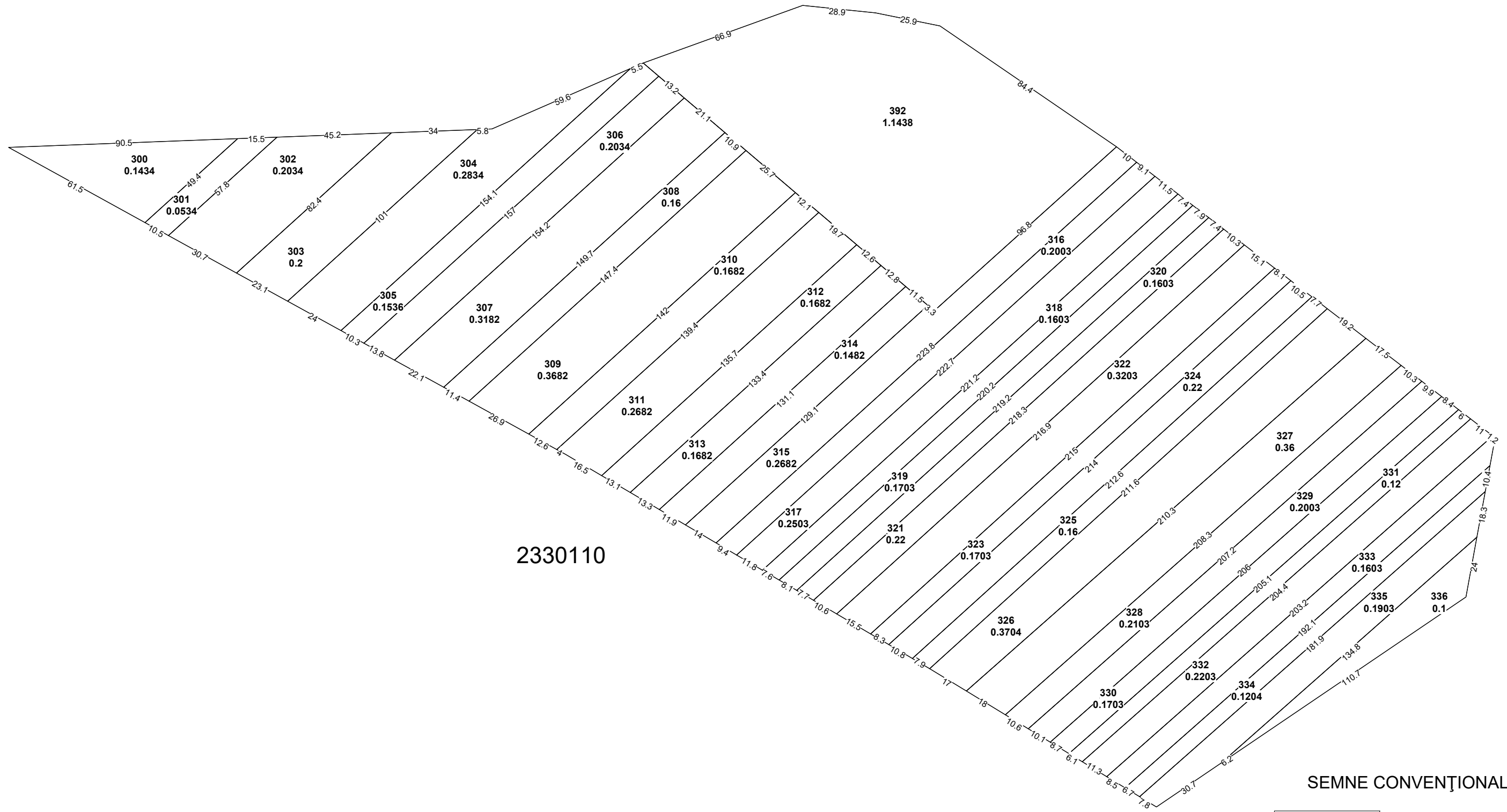

Scara 1:2000



Directorul firmei \_\_\_\_\_/semnătura/  
Specialistul licențiat \_\_\_\_\_/semnătura/  
Planul cadastral întocmit de \_\_\_\_\_/semnătura/  
Data tipării: 17.05.2023

Scara 1:2000

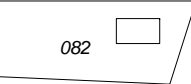
SEMNE CONVENȚIONALE

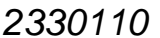
-  - numărul cadastral al parcelei
-   - numărul poștal
-  - codul cadastral al sectorul

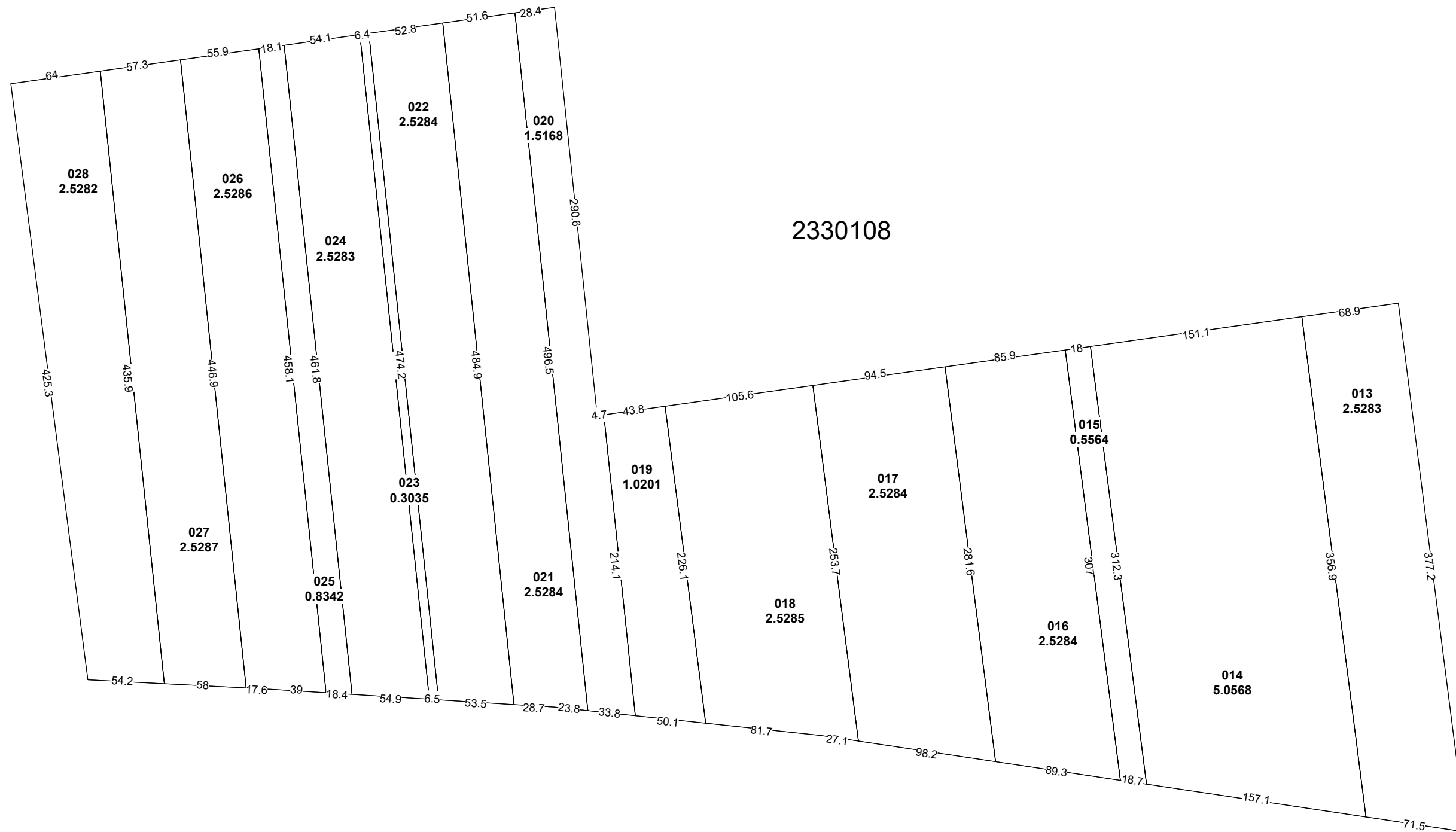





2330108

Directorul firmei \_\_\_\_\_/semnătura/  
Specialistul licențiat \_\_\_\_\_/semnătura/  
Planul cadastral întocmit de \_\_\_\_\_/semnătura/  
Data tipării: 17.05.2023

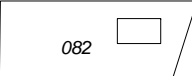
Scara 1:2000

SEMNE CONVENȚIONALE

-  - numărul cadastral al parcelei
-   - numărul poștal
-  - codul cadastral al sectorul







2330105

Directorul firmei \_\_\_\_\_/semnătura/  
Specialistul licențiat \_\_\_\_\_/semnătura/  
Planul cadastral întocmit de \_\_\_\_\_/semnătura/  
Data tipării: 17.05.2023

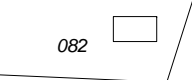
Scara 1:2000

SEMNE CONVENȚIONALE

-  - numărul cadastral al parcelei
-   - numărul poștal
-  - codul cadastral al sectorul