

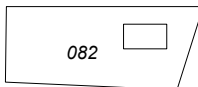

Directorul firmei _____/semnătura/
Specialistul licențiat _____/semnătura/
Planul cadastral întocmit de _____/semnătura/
Data tipării:21.04.2023

Scara 1:2000

SEMNE CONVENȚIONALE

-  082 - numărul cadastral al parcelei
-  12  614a - numărul poștal
- 2723116 - codul cadastral al sectorul

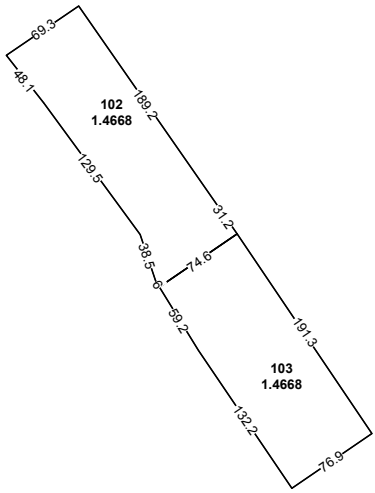

2723107

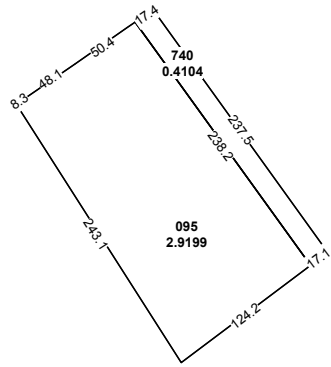

2723118

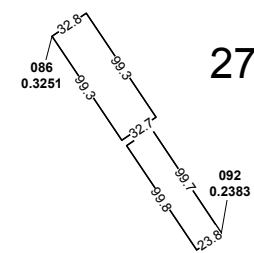



2723108

Directorul firmei _____/semnătura/
Specialistul licențiat _____/semnătura/
Planul cadastral întocmit de _____/semnătura/
Data tipării:21.04.2023

Scara 1:2000

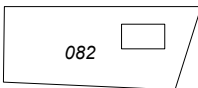
SEMNE CONVENȚIONALE

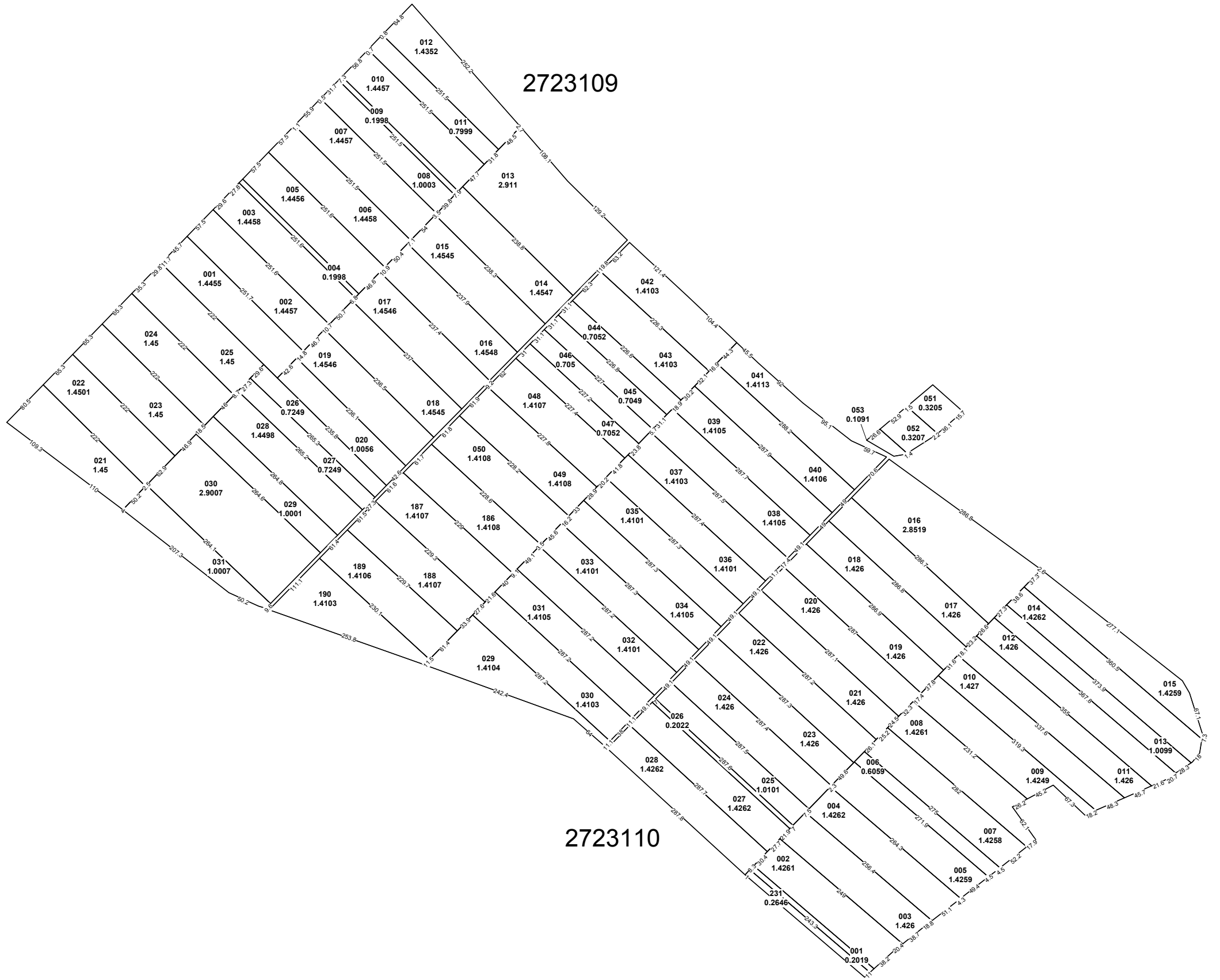

-  - numărul cadastral al parcelei
  - numărul poștal
2723107 - codul cadastral al sectorul



Directorul firmei _____/semnătura/
Specialistul licențiat _____/semnătura/
Planul cadastral întocmit de _____/semnătura/
Data tipării:21.04.2023

Scara 1:2000

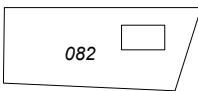
SEMNE CONVENȚIONALE

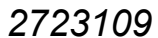

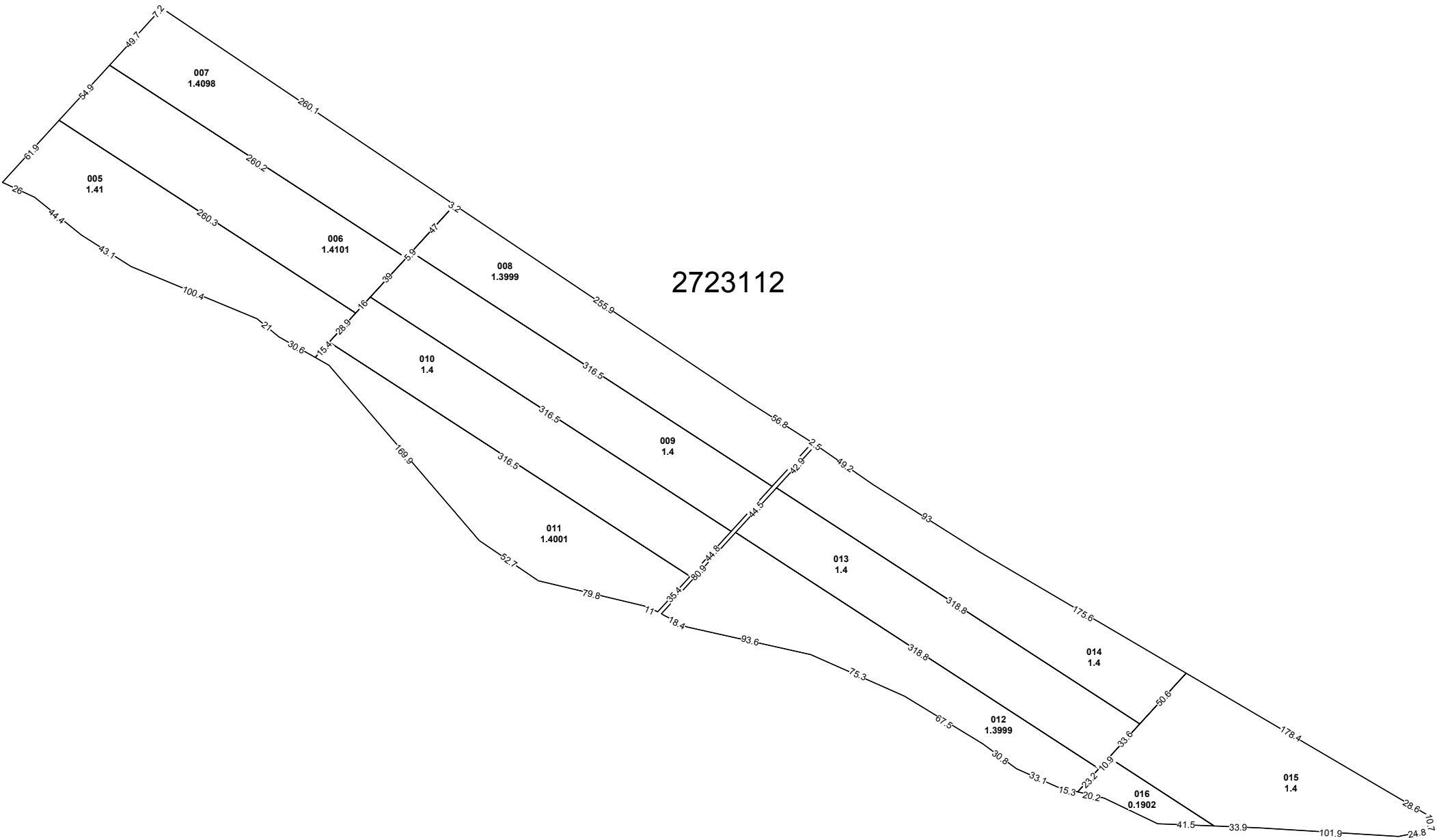
-  - numărul cadastral al parcelei
-   - numărul poștal
-  - codul cadastral al sectorul



Directorul firmei _____/semnătura/
Specialistul licențiat _____/semnătura/
Planul cadastral întocmit de _____/semnătura/
Data tipării:21.04.2023

Scara 1:2000

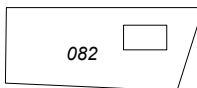
SEMNE CONVENȚIONALE

-  082 - numărul cadastral al parcelei
-  12  614a - numărul poștal
- 2723112 - codul cadastral al sectorul

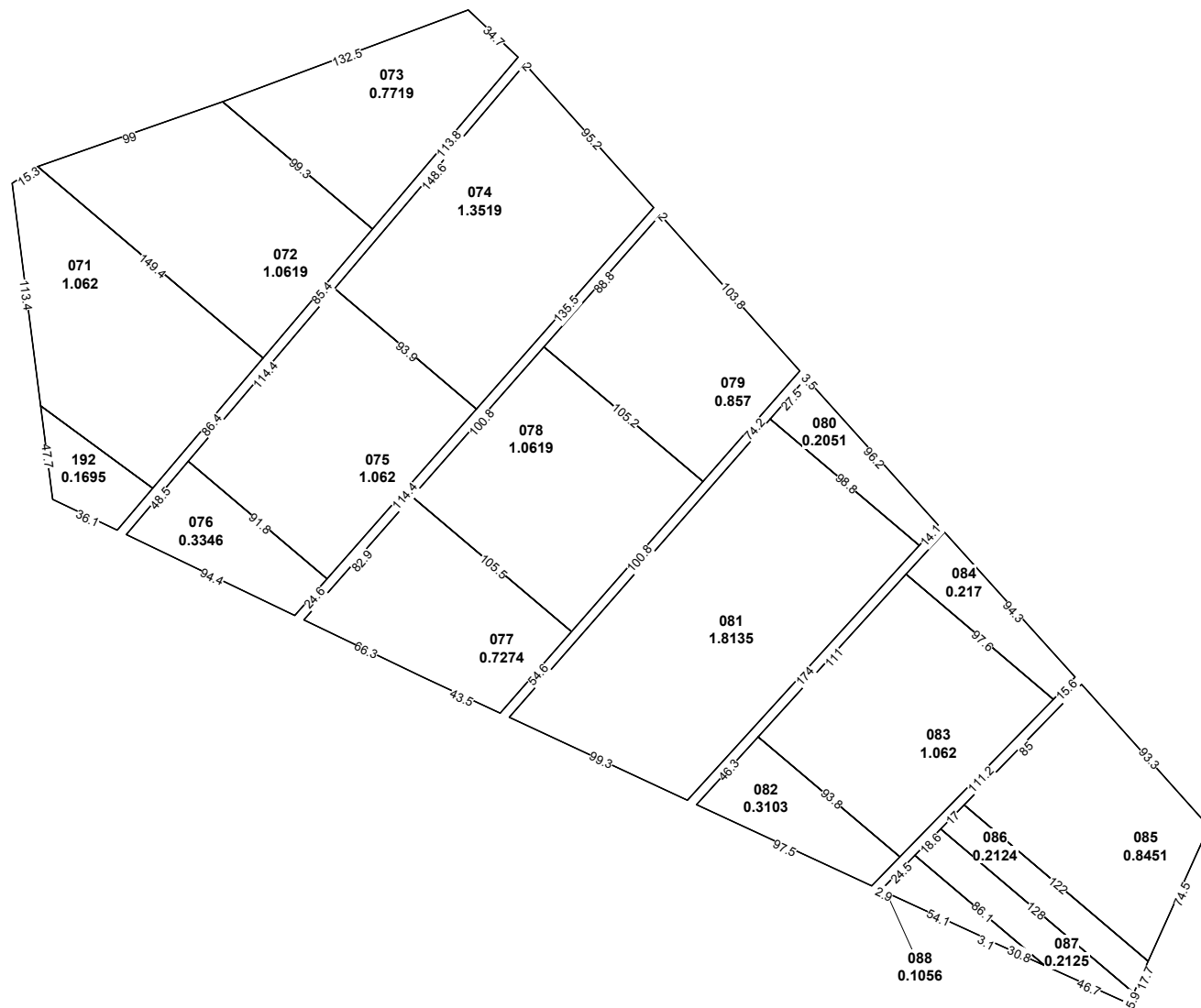
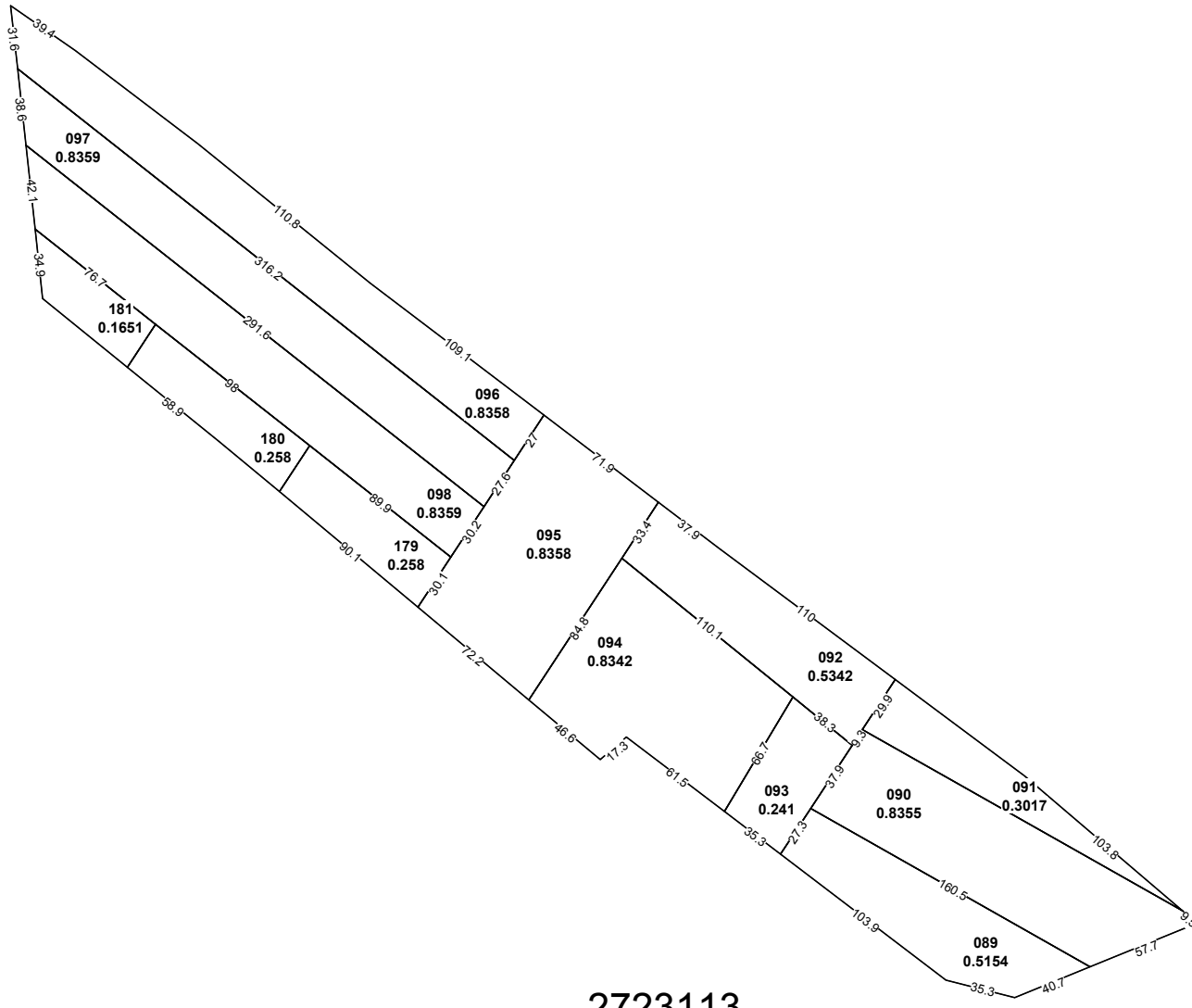

SEMNE CONVENȚIONALE

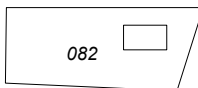
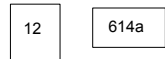
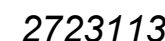

-  - numărul cadastral al parcelei
-  - numărul poștal
-  - codul cadastral al sectorul

Directorul firmei _____/semnătura/
Specialistul licențiat _____/semnătura/
Planul cadastral întocmit de _____/semnătura/
Data tipăririi:21.04.2023

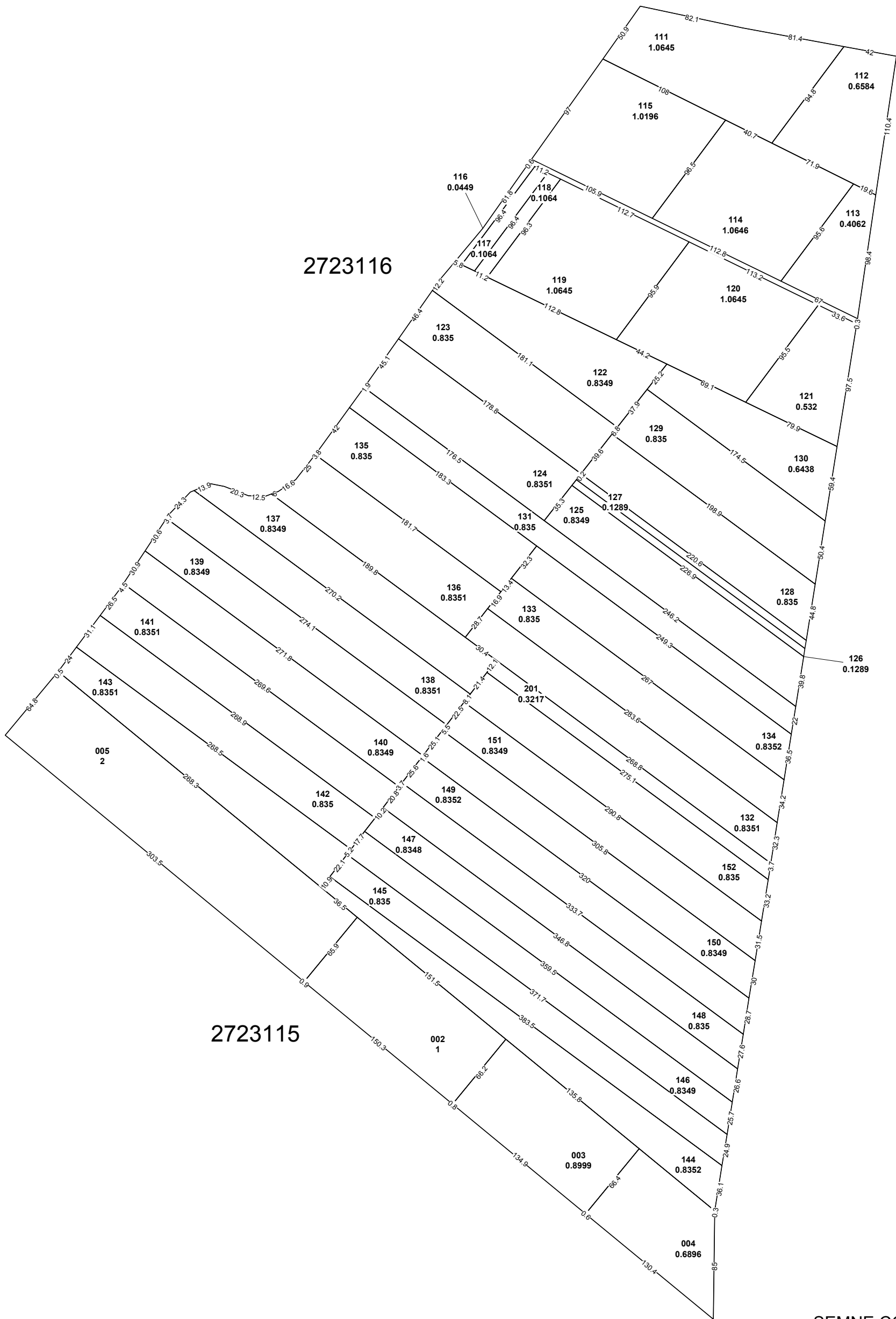
Scara 1:2000

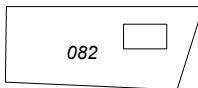

SEMNE CONVENȚIONALE

-  082 - numărul cadastral al parcelei
-  12  614a - numărul poștal
- 2723115 - codul cadastral al sectorul

Directorul firmei _____/semnătura/
Specialistul licențiat _____/semnătura/
Planul cadastral întocmit de _____/semnătura/
Data tipării:21.04.2023

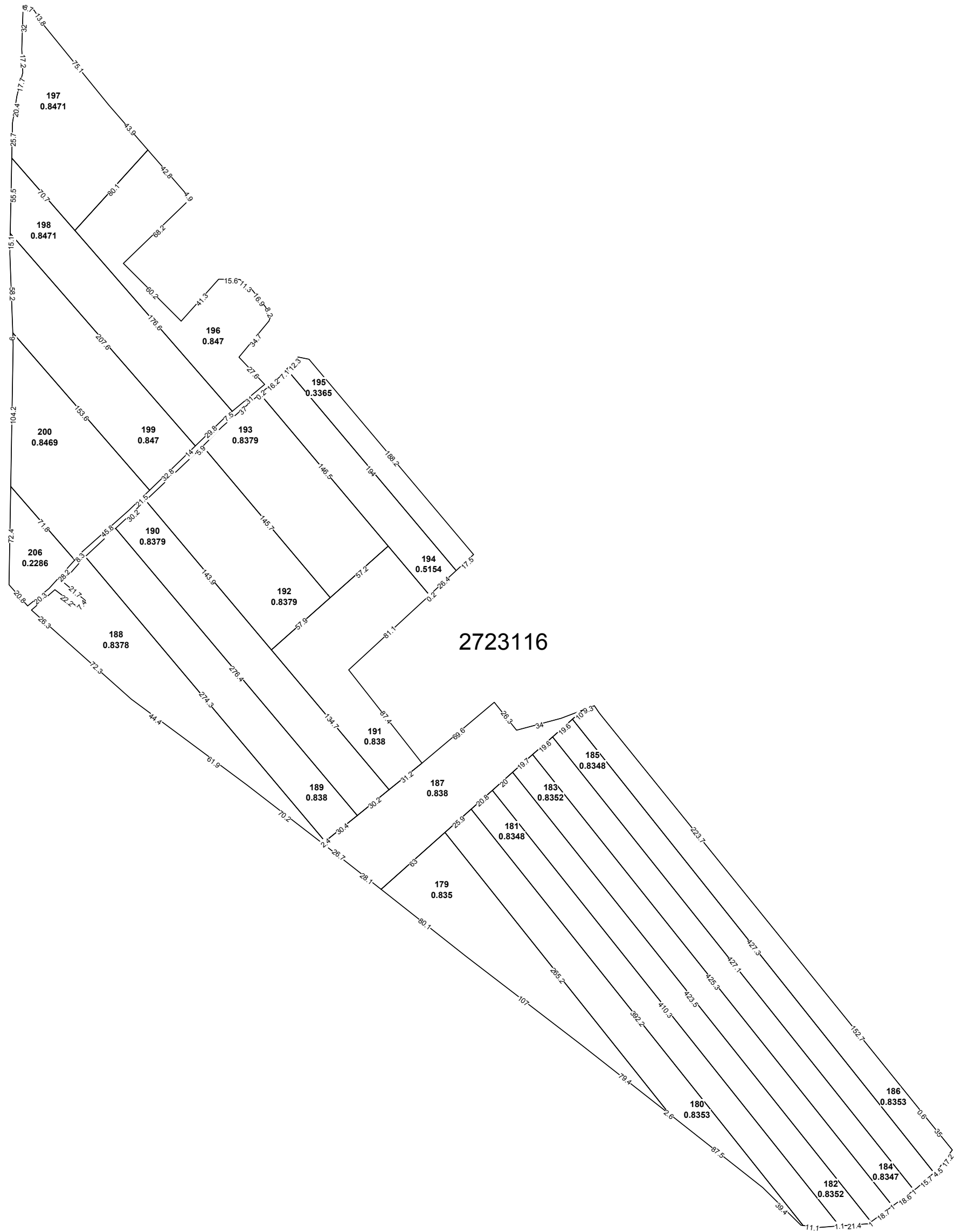

Scara 1:2000



Directorul firmei _____/semnătura/
Specialistul licențiat _____/semnătura/
Planul cadastral întocmit de _____/semnătura/
Data tipării: 21.04.2023

Scara 1:2000

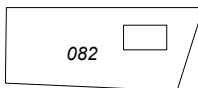
SEMNE CONVENȚIONALE

-  - numărul cadastral al parcelei
-   - numărul poștal
- 2723116** - codul cadastral al sectorul